

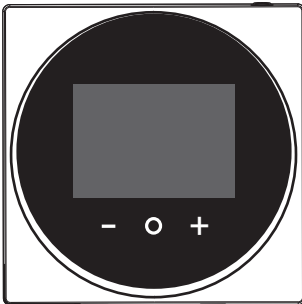

# Installation and operation manual

## Human Comfort Interface



BRC1HDDAW  
BRC1HDDAS  
BRC1HDDAK

Installation and operation manual  
Human Comfort Interface

English

## Table of contents

<b>1</b>	<b>General safety precautions</b>	<b>2</b>
1.1	For the user .....	2
1.2	For the installer.....	2
<b>2</b>	<b>About this document</b>	<b>3</b>
<b>For the user</b>		<b>4</b>
<b>3</b>	<b>User interface: Overview</b>	<b>4</b>
3.1	Buttons .....	4
3.2	Status icons.....	4
3.3	Status indicator.....	4
<b>4</b>	<b>Operation</b>	<b>4</b>
4.1	Basic usage.....	4
4.1.1	Home screen.....	4
4.1.2	Operation screens.....	5
4.1.3	Main menu .....	5
4.2	Space heating/cooling control .....	5
4.2.1	To turn ON/OFF space heating/cooling operation .....	5
4.2.2	To change the room temperature .....	5
4.2.3	To change the space operation mode .....	6
4.3	Domestic hot water control.....	6
4.3.1	To turn ON/OFF domestic hot water operation.....	6
4.3.2	To change the domestic hot water temperature .....	6
4.3.3	Using DHW powerful operation.....	6
4.4	Advanced usage.....	7
<b>5</b>	<b>Maintenance and service</b>	<b>7</b>
5.1	Overview: Maintenance and service .....	7
<b>6</b>	<b>Troubleshooting</b>	<b>7</b>
6.1	Overview: Troubleshooting.....	7
<b>For the installer</b>		<b>7</b>
<b>7</b>	<b>About the box</b>	<b>7</b>
7.1	To unpack the user interface .....	7
<b>8</b>	<b>Preparation</b>	<b>7</b>
8.1	Wiring requirements .....	7
<b>9</b>	<b>Installation</b>	<b>7</b>
9.1	Mounting the user interface.....	7
9.1.1	To mount the user interface .....	8
9.2	Connecting the electrical wiring.....	8
9.2.1	To connect the electrical wiring.....	8
9.3	Closing the user interface.....	9
9.3.1	To close the user interface.....	9
<b>10</b>	<b>Starting up the system</b>	<b>9</b>
<b>11</b>	<b>Maintenance</b>	<b>9</b>
11.1	Maintenance safety precautions.....	9
11.2	To clean the user interface.....	9

## 1 General safety precautions

Please read these general safety precautions carefully before installing air conditioning equipment, and be sure to install the equipment correctly.

Failure to follow these instructions properly may result in property damage or personal injury, which may be serious depending on the circumstances.

### Meaning of warnings and symbols

These safety messages are used to attract your attention. The meaning of each safety message is described below:

 **WARNING**  
Indicates a situation that could result in death or serious injury.

 **CAUTION**  
Indicates a situation that could result in minor or moderate injury.

 **DANGER**  
Indicates a situation that results in death or serious injury.

 **DANGER: RISK OF EXPLOSION**  
Indicates a situation that could result in explosion.

 **INFORMATION**  
Indicates useful tips or additional information.

 **NOTICE**  
Indicates a situation that could result in equipment or property damage.

### 1.1 For the user

 **INFORMATION**  
Also see the operation manual delivered with the outdoor and indoor unit.

 **WARNING**  
Do NOT play with the unit or its user interface. Accidental operation by a child may result in impairment of bodily functions and harm health.

 **WARNING**  
To prevent electric shocks or fire:

- Do NOT operate the user interface with wet hands.
- Do NOT disassemble the user interface and touch interior parts. Contact your dealer.
- Do NOT modify or repair the user interface. Contact your dealer.
- Do NOT relocate or reinstall the user interface by yourself. Contact your dealer.

 **WARNING**  
Do NOT use flammable materials (e.g. hairspray or insecticide) near the user interface.

 **NOTICE**  
To clean the user interface, do NOT use organic solvents, such as paint thinner. **Possible consequence:** damage, electrical shock, or fire.

### 1.2 For the installer

The precautions described in this document cover very important topics, follow them carefully.

 **INFORMATION**  
This user interface is an option and cannot be used standalone. It can ONLY be used in combination with a main user interface. Also see the installation and operation manual of the indoor and outdoor units.



### WARNING

Improper installation or attachment of equipment or accessories could result in electrical shock, short-circuit, leaks, fire or other damage to the equipment. ONLY use accessories, optional equipment and spare parts made or approved by Daikin.



### WARNING

All field wiring and components MUST be installed by a licensed electrician and MUST comply with the applicable legislation.



### NOTICE

The user interface MUST be mounted indoors.



### NOTICE

When the user interface is used as room thermostat, select an installation location where the average temperature in the room can be detected.

Do NOT install the user interface in the following places:

- In places where it is exposed to direct sunlight.
- In places where it is near a heat source.
- In places that are affected by outside air or air draught due to e.g. door opening/closing.
- In places where the display can easily get dirty.
- In places where there is NO easy access to the controls.
- In places with temperatures  $<-10^{\circ}\text{C}$  and  $>50^{\circ}\text{C}$ .
- In places where the relative humidity is  $>95\%$ .
- In places where there is machinery that emits electromagnetic waves. Electromagnetic waves may disturb the control system, and cause malfunction of the equipment.
- In places where it may be exposed to water, or in generally moist areas.

If you are NOT sure how to install or operate the unit, contact your dealer.

After finishing installation:

- Conduct a trial operation to check for faults.
- Explain the user how to operate the user interface.
- Ask the user to store the manual for future reference.



### INFORMATION

Consult your dealer regarding the relocation and reinstallation of the user interface.

## 2 About this document

### Target audience

Authorised installers + end users

### Documentation set

This document is part of a documentation set. The complete set consists of:

- **Installation and operation manual:**
  - Installation instructions
  - Basic operation instructions
  - Format: Paper (in the box of the user interface)
- **Installer and user reference guide:**
  - Extended installation and operation information
  - Format: Digital files on <http://www.daikineurope.com/support-and-manuals/product-information/>
- **Declaration of conformity:**
  - Hereby, Daikin Europe N.V. declares that the radio equipment type BRC1HHDA is in compliance with the Directive 2014/53/EU. The original declaration of conformity is available from the BRC1HHDA product pages <https://qr.daikin.eu/?N=BRC1HHDW>, <https://qr.daikin.eu/?N=BRC1HHDS>, and <https://qr.daikin.eu/?N=BRC1HHDK>.
  - Format: Digital file from the product pages



(BRC1HHD AW)



(BRC1HHD AS)



(BRC1HHD AK)

Latest revisions of the supplied documentation may be available on the regional Daikin website or via your dealer.

The original documentation is written in English. All other languages are translations.

### Technical engineering data

- A **subset** of the latest technical data is available on the regional Daikin website (publicly accessible).
- The **full set** of latest technical data is available on the Daikin Business Portal (authentication required).

## 3 User interface: Overview

### For the user

## 3 User interface: Overview

### 3.1 Buttons

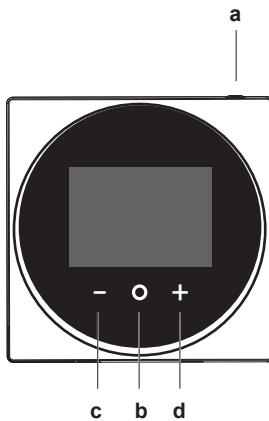

- a ON/OFF
- When space heating/cooling and/or domestic hot water operation is OFF, press to turn it ON.
  - When space heating/cooling and/or domestic hot water operation is ON, press to turn it OFF.
- b CYCLE/ENTER/ACTIVATE /CONFIRM
- From the home screen, short press to cycle through the operation screens.
  - From the home screen, long press to go to the main menu.
  - In the main menu, short press to enter one of the menus.
  - In any of the menus, activate/confirm a function, value, or setting.
- c ACTIVATE/CYCLE/ADJUST
- On the room temperature/domestic hot water operation screen, activate the setpoint screen.
  - In the main menu, cycle left.
  - In any of the menus/operation screens, adjust a function, value, or setting (default: decrease).
- d ACTIVATE/CYCLE/ADJUST
- On the room temperature/domestic hot water operation screen, activate the setpoint screen.
  - In the main menu, cycle right.
  - In any of the menus/operation screens, adjust a function, value, or setting (default: increase).

### 3.2 Status icons

Icon	Description
	<b>System operation OFF.</b> Indicates that space heating/cooling operation and/or domestic hot water operation are turned OFF.
	<b>Bluetooth.</b> <sup>(1)</sup> Indicates that Bluetooth is activated, and that the user interface is ready to perform a software update.
	<b>Heating operation.</b> Indicates that the system is operating in Heating operation mode.
	<b>Cooling operation.</b> Indicates that the system is operating in Cooling operation mode.

<sup>(1)</sup> The Bluetooth® word mark and logos are registered trademarks owned by the Bluetooth SIG, Inc. and use of such marks by Daikin Europe N.V. is under license. Other trademarks and trade names are those of their respective owners.

Icon	Description
	<b>Powerful operation.</b> Indicates that Powerful operation is active.
	<b>Emergency operation.</b> Indicates that Emergency operation is active.
	<b>Malfunction.</b> Indicates that a malfunction occurred.



#### INFORMATION

When the user interface signals **Emergency operation** or **Malfunction**, see the main user interface to see what is wrong.



#### INFORMATION

For more information on the Bluetooth signal and the software update, see the installer and user reference guide.

### 3.3 Status indicator

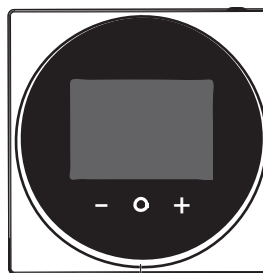

a

a Status indicator



#### INFORMATION

For a full description of the behaviour of the status indicator, see the installer and user reference guide.

## 4 Operation

### 4.1 Basic usage

#### 4.1.1 Home screen

The home screen displays the actual room temperature, and all kinds of information through status icons. After a period of operation inactivity the user interface will always revert to the home screen.







## **i** INFORMATION

The user interface is equipped with a power saving function that causes the screen to darken after a period of inactivity. To make the screen light up again, press one of the buttons.

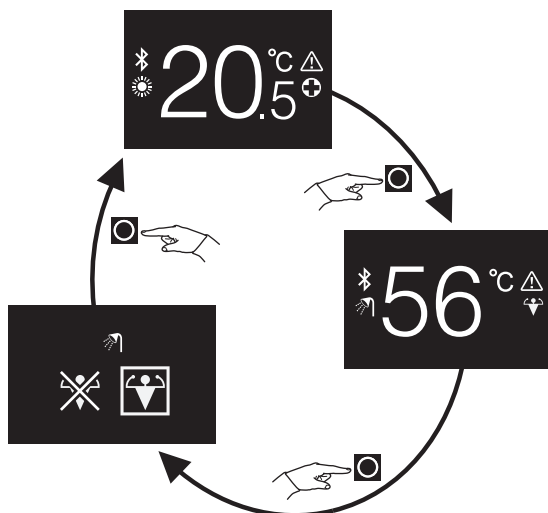

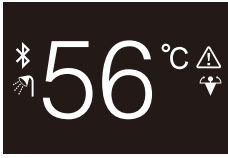

### 4.1.2 Operation screens



From the home screen, press  (shortly) to cycle through the operation screens.





Operation screen	Description
	<b>Room temperature.</b> See the actual room temperature, and control the (desired) room temperature.
	<b>Domestic hot water temperature.</b> See the actual domestic hot water temperature, and control the (desired) domestic hot water temperature (i.e. tank heating operation).
	<b>Powerful operation.</b> Activate or deactivate Powerful operation (i.e. fast tank heating operation).

### 4.1.3 Main menu

From the home screen, press  and keep it pressed until you enter the main menu. Use  and  to cycle through the menus. Press  again to enter one of the menus.

Menu	Description
	<b>Information.</b> See information about the user interface.
	<b>Bluetooth.</b> Make the user interface send out a Bluetooth signal to perform a software update.
	<b>Return.</b> Return to the home screen.

Menu	Description
	<b>Settings.</b> Make user interface settings.
	<b>Space operation mode.</b> Set the space operation mode.

## **i** INFORMATION

For more information on user interface information, software updates, and settings, see the installer and user reference guide.

## 4.2 Space heating/cooling control

### 4.2.1 To turn ON/OFF space heating/cooling operation

**Prerequisite:** The user interface displays the home screen.

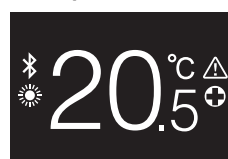

- 1 press the  button.

**Result:** The user interface will turn ON or OFF space heating/cooling operation, depending on the previous state.

## **i** INFORMATION

To indicate operation is OFF, the user interface displays "OFF" on the home screen.





### 4.2.2 To change the room temperature

- 1 From the home screen, press  or  to activate the setpoint screen.

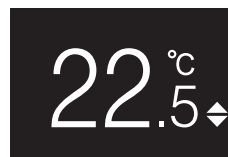

- 2 Use  and  to change the setpoint.



- 3 Press  to confirm the setpoint.

**Result:** The user interface implements changes and returns to the home screen.

## **i** INFORMATION

When operation is OFF, the user interface does not allow setpoint changes.

## 4 Operation

### INFORMATION

Depending on settings made on the main user interface, setpoint changes might not be possible. If this is the case, pressing **+** or **-** from the room temperature or domestic hot water operation screen is futile.

### INFORMATION

The way you control the room temperature depends on the temperature control method that is set on the main user interface. Depending on this, the setpoint screen can look different from the one represented in this manual.

If the room temperature is controlled with weather dependent leaving water temperature control, the setpoint screen features a shift value and not a temperature value.



For more information, see the installer and user reference guide, and the documentation of the indoor units.

### 4.2.3 To change the space operation mode

- 1 From the home screen, press  and keep it pressed until you enter the main menu.

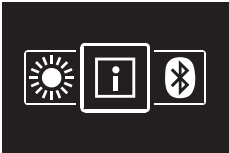

- 2 Use **-** and **+** to navigate to the space operation mode menu.



- 3 Press  to enter the menu.



- 4 Use **-** and **+** to select a space operation mode, and press  to activate it.

**Result:** The user interface implements changes and returns to the home screen.

## 4.3 Domestic hot water control

### 4.3.1 To turn ON/OFF domestic hot water operation

- 1 From the home screen, press  to go to the domestic hot water operation screen.



- 2 press the  button.

**Result:** The user interface will turn ON or OFF domestic hot water operation, depending on the previous state.

### INFORMATION

To indicate operation is OFF, the user interface displays "OFF" on the home screen.

OFF

### 4.3.2 To change the domestic hot water temperature

- 1 From the home screen, press  to go to the domestic hot water operation screen.

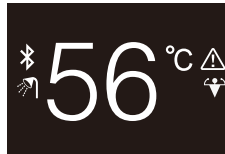

- 2 Press **+** or **-** to activate the setpoint screen.

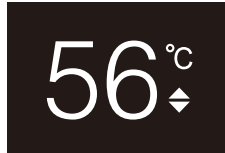

- 3 Use **+** and **-** to change the setpoint.



- 4 Press  to confirm the setpoint.

**Result:** The user interface implements changes and returns to the domestic hot water operation screen.

### INFORMATION

When operation is OFF, the user interface does not allow setpoint changes.

### INFORMATION

Depending on settings made on the main user interface, setpoint changes might not be possible. If this is the case, pressing **+** or **-** from the room temperature or domestic hot water operation screen is futile.

### 4.3.3 Using DHW powerful operation

- 1 From the home screen, press  to go to the Powerful operation screen.

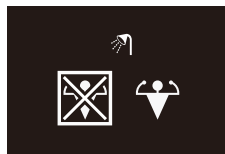

- 2 To activate Powerful operation, use **+** and **-** to select "activate".



- 3 To deactivate Powerful operation, use **+** and **-** to select "deactivate".



- 4 Press **OK** to confirm your selection.

**Result:** The user interface implements changes and returns to the home screen.

### **i** INFORMATION

To indicate Powerful operation is active, the user interface displays the Powerful icon on the domestic hot water operation screen.

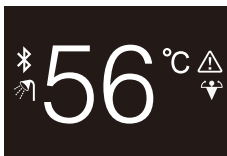

### **i** INFORMATION

For more information on Powerful operation, see the installer reference guide and the user reference guide of the units.

## 4.4 Advanced usage

For how to consult user interface information, make user interface settings, and perform a software update, see the installer and user reference guide.

## 5 Maintenance and service

### 5.1 Overview: Maintenance and service

When the user interface needs to be maintained or serviced, consult your dealer.

## 6 Troubleshooting

### 6.1 Overview: Troubleshooting

When the system is in error, the user interface displays **!** on the home screen. Simultaneously, the main user interface displays an error code. Check the main user interface to see the error code. For a list of error codes and what they mean, see the documentation of the indoor unit. To have the error solved, consult your dealer.

## For the installer

## 7 About the box

### 7.1 To unpack the user interface

- 1 Open the box.
- 2 Separate the accessories.

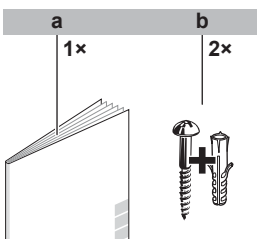

- a Installation and operation manual  
b Wood screws + wall plugs (Ø4.0x30)

## 8 Preparation

### 8.1 Wiring requirements

All wiring must comply with the following requirements:

Wire specification	Value
Type	Sheathed vinyl cord or cable (2 wires)

Wire specification	Value
Section	0.75~1.25 mm <sup>2</sup>
Maximum length	500 m

## 9 Installation

### **!** NOTICE

During the installation of the controller, keep the installation environment dust-free in order to avoid any particles entering the PCB side of the controller.

### 9.1 Mounting the user interface

Before you can mount the user interface, you have to determine the wiring routing, and accordingly, remove a piece of the user interface's rear casing.

The wiring can be routed from the top, the rear, the left, or the bottom. Remove a piece of the rear casing according to the illustration:

## 9 Installation

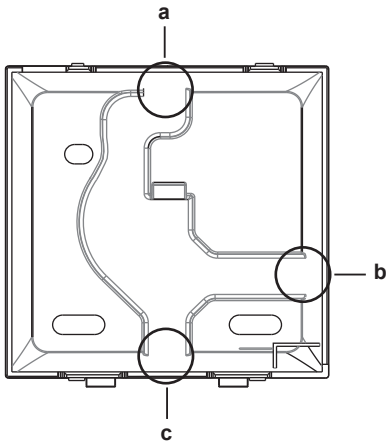

- a Wiring from the top
- b Wiring from the left
- c Wiring from the bottom

In case you are routing the wiring from the rear, you don't have to remove anything.

### 9.1.1 To mount the user interface

- 1 Take the screws and plugs from the accessory bag.
- 2 Mount the rear casing to a flat surface.

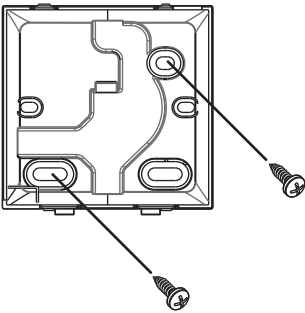

#### **i** INFORMATION

If required (e.g. when mounting to a flush-mounted electrical installation box), mount the rear casing by way of the knockout holes.

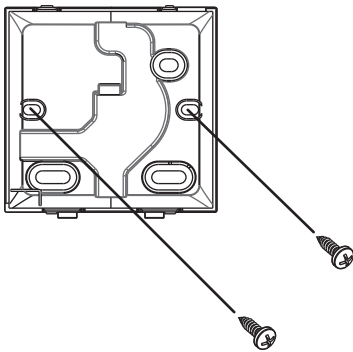

#### **!** NOTICE

When mounting the rear casing to a flush-mounted electrical installation box inside a wall, make sure that that wall is completely flat.

#### **!** NOTICE

Be careful not to distort the rear casing by overtightening the mounting screws.

## 9.2 Connecting the electrical wiring

#### **!** NOTICE

The wiring for connection is NOT included.

#### **!** NOTICE

When wiring, run the wiring away from the power supply wiring in order to avoid receiving electric noise (external noise).

### 9.2.1 To connect the electrical wiring

Connect user interface terminals P1/P2 to indoor unit terminals P1/P2.

#### From the top

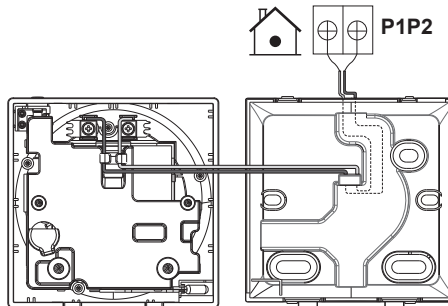

#### From the rear

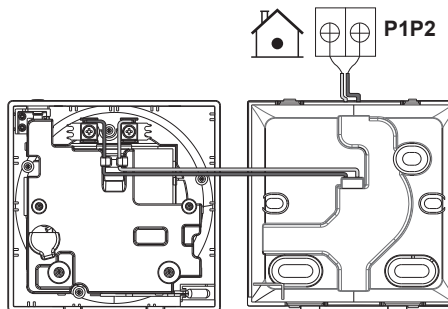

#### From the left

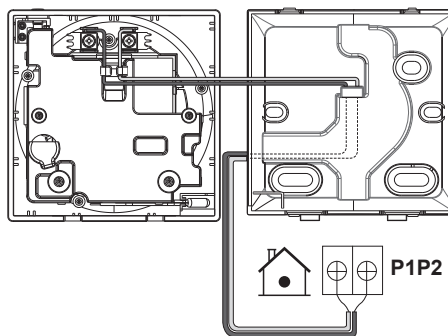



## From the bottom

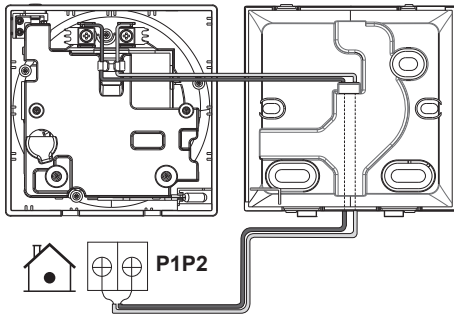

## 9.3 Closing the user interface



### CAUTION

NEVER touch the internal parts of the user interface.



### CAUTION

When closing the user interface, be careful not to pinch the wiring.



### NOTICE

To prevent damage, make sure the front of the user interface is clicked into the rear casing securely.

### 9.3.1 To close the user interface

- 1 Click the front of the user interface into the rear casing.

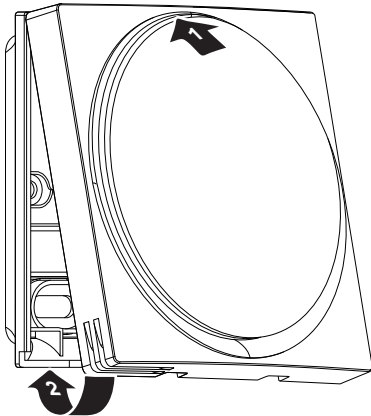

## 10 Starting up the system

The user interface gets its power from the indoor unit. It will start up as soon as it is connected. For the user interface to be operable, make sure the indoor unit is powered on.

Before the user interface is ready for operation, it will synchronise with the main user interface and go through the following start-up sequence:

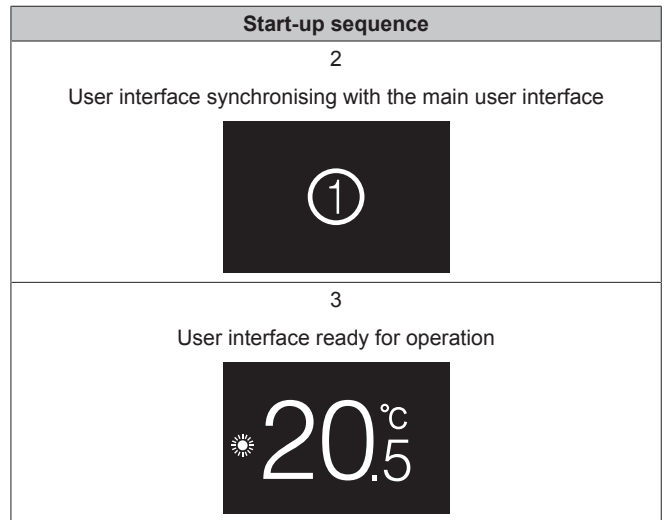
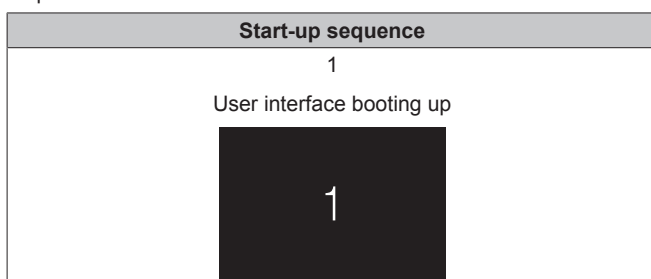

## 11 Maintenance

### 11.1 Maintenance safety precautions



### WARNING

Before carrying out any maintenance or repair activities, stop system operation with the user interface, and turn off the power supply circuit breaker. **Possible consequence:** electrical shock or injury.



### NOTICE

To clean the user interface, do NOT use organic solvents, such as paint thinner. **Possible consequence:** damage, electrical shock, or fire.



### WARNING

Do NOT wash the user interface. **Possible consequence:** electric leakage, electrical shock, or fire.



### INFORMATION

When the dirt on the surface cannot be removed easily while cleaning the user interface, soak the cloth in neutral detergent diluted with water, squeeze the cloth tightly, and clean the surface. Afterwards, wipe dry with a dry cloth.

### 11.2 To clean the user interface

- 1 Wipe the screen and other surface parts of the user interface with a dry cloth.





**ERC**



4P534400-1 B 0000000U



**UA. TR. 028**



**W005 18**

Maximum Voltage: DC 17.6 V  
Power Consumption: Max 1.94 VA

Copyright 2018 Daikin

**DAIKIN EUROPE N.V.**

Zandvoordestraat 300, B-8400 Oostende, Belgium

4P534400-1B 2021.06