



OPERATION MANUAL

DAIKIN ROOM AIR CONDITIONER

MODELS

- DTXF25T2VMA
- DTXF35T2VMA
- DTXF50T2VMA

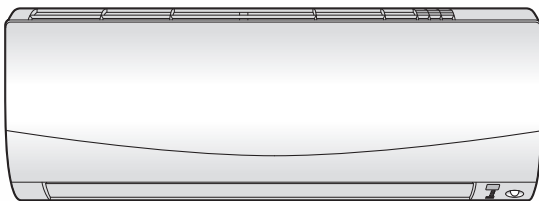

Feature

For your comfort and energy saving



INTELLIGENT EYE

The INTELLIGENT EYE sensor detects the human movement in a room. If no one is in the room more than 20 minutes, the operation automatically changes to energy saving operation.

▶Page 14

Other functions



COMFORT AIRFLOW

The airflow direction is upward while in COOL operation, and downward while in HEAT operation. This function prevents cold or warm air from blowing directly on your body.

▶Page 13



OUTDOOR UNIT QUIET











OUTDOOR UNIT QUIET operation lowers the noise level of the outdoor unit. This function is useful when you need to consider the noise for your neighbourhood. ▶Page 19

Contents

■ Read before Operation

| | |
|------------------------------------|---|
| Safety Precautions | 3 |
| Name of Parts | 5 |
| Preparation before Operation | 8 |

■ Operation

| | |
|---|----|
|  AUTO · DRY · COOL · HEAT · FAN ONLY Operation | 9 |
|  Adjusting the Airflow Direction | 11 |
|  Adjusting the Airflow Rate | 12 |
|  COMFORT AIRFLOW Operation..... | 13 |
|  INTELLIGENT EYE Operation..... | 14 |
|  POWERFUL Operation | 16 |
|  ECONO Operation..... | 17 |
|  OUTDOOR UNIT QUIET Operation..... | 19 |
|  OFF TIMER Operation | 20 |
|  ON TIMER Operation..... | 21 |

■ Care

| | |
|-------------------------|----|
| Care and Cleaning | 22 |
|-------------------------|----|

■ Troubleshooting

| | |
|-----------------------|----|
| Troubleshooting | 27 |
|-----------------------|----|



ECONO

This function enables efficient operation by limiting the maximum power consumption. It is useful when using the air conditioner and other electrical devices simultaneously. ▶Page 17

Safety Precautions



Read the precautions in this manual carefully before operating the unit.



This appliance is filled with R32.





- Keep this manual where the user can easily find it.
- The precautions described herein are classified as WARNING and CAUTION. They both contain important information regarding safety. Be sure to observe all precautions without fail.

WARNING

Failure to follow these instructions properly may result in personal injury or loss of life.

CAUTION

Failure to follow these instructions properly may result in property damage or personal injury, which may be serious depending on the circumstances.

| | | |
|---|---|---|
|  Never attempt. |  Be sure to follow the instructions. |  Be sure to establish an earth connection. |
|  Never touch the air conditioner nor the remote controller with wet hands. |  Never wet the air conditioner nor the remote controller | |

- After reading, keep this manual in a convenient place so that you can refer to it whenever necessary. If the equipment is transferred to a new user, be sure also to hand over the manual.

WARNING



- Do not use means to accelerate the defrosting process or to clean, other than those recommended by the manufacturer.
- The appliance must be stored in a room without continuously operating ignition sources (for example: open flames, an operating gas appliance or an operating electric heater).
- Do not pierce or burn.
- Be aware that refrigerants may not contain an odour.
- The appliance must be installed, operated and stored in a room with floor area larger than $-*m^2$ for 25/35/50 class.
* Since the maximum refrigerant charge of the models is below 1.84kg, it does not have any limitation for the minimum floor area.
- To avoid fire, explosion or injury, do not operate the unit when harmful gases (e.g. flammable or corrosive) are detected near the unit.
- Be aware that prolonged, direct exposure to cool or warm air from the air conditioner, or to air that is too cool or too warm, can be harmful to your physical condition and health.
- Do not place objects, including rods, your fingers, etc., in the air inlet or outlet. Product damage or personal injury may result due to contact with the air conditioner's high-speed fan blades.
- Do not attempt to repair, dismantle, reinstall or modify the air conditioner yourself as this may result in water leakage, electric shocks or fire hazards.
- Do not use flammable spray near the air conditioner, or otherwise fire may result.
- When the air conditioner is malfunctioning (giving off a burning odour, etc.) turn off power to the unit and contact your local dealer. Continued operation under such circumstances may result in a failure, electric shocks or fire hazards.
- Do not use a refrigerant other than the one indicated on the outdoor unit (R32) when installing, moving or repairing. Using other refrigerants may cause trouble or damage to the unit, and personal injury.



- To avoid electric shocks, do not operate with wet hands.



- Beware of fire in case of refrigerant leakage. If the air conditioner is not operating correctly, i.e. not generating cool or warm air, refrigerant leakage could be the cause. Consult your dealer for assistance. The refrigerant within the air conditioner is safe and normally does not leak. However, in the event of a leakage, contact with a naked burner, heater or cooker may result in generation of noxious gas. Do not use the air conditioner until a qualified service person confirms that the leakage has been repaired.
- Do not attempt to install or repair the air conditioner yourself. Improper workmanship may result in water leakage, electric shocks or fire hazards. Please contact your local dealer or qualified personnel for installation and maintenance work.
- If the air conditioner is malfunctioning (giving off a burning odour, etc.), turn off power to the unit and contact your local dealer. Continued operation under such circumstances may result in a failure, electric shocks or fire hazards.
- Be sure to install an earth leakage circuit breaker. Failure to install an earth leakage circuit breaker may result in electric shocks or fire.



- Be sure to earth the unit. Do not earth the unit to a utility pipe, lightning conductor or telephone earth lead. Imperfect earthing may result in electric shocks.

CAUTION



- Do not use the air conditioner for purposes other than those for which it is intended. Do not use the air conditioner for cooling precision instruments, food, plants, animals or works of art as this may adversely affect the performance, quality and/or longevity of the object concerned.
- Do not expose plants or animals directly to the airflow from the unit as this may cause adverse effects.
- Do not place appliances that produce naked flames in places exposed to the airflow from the unit as this may impair combustion of the burner.

CAUTION



- Do not block the air inlets nor outlets. Impaired airflow may result in insufficient performance or trouble.
 - Do not sit on the outdoor unit, put things on the unit, or pull the unit. Doing so may cause accidents, such as falling or toppling down, thus resulting in injury, product malfunctioning, or product damage.
 - Do not give impact to the indoor and outdoor units, or otherwise product damage may result.
 - Do not place objects that are susceptible to moisture directly beneath the indoor or outdoor units. Under certain conditions, condensation on the main unit or refrigerant pipes, air filter dirt or drain blockage may cause dripping, resulting in fouling or failure of the object concerned.
 - After prolonged use, check the unit stand and its mounts for damage. If they are left in a damaged condition, the unit may fall and cause injury.
 - To avoid injury, do not touch the air inlet or aluminium fins of the indoor or outdoor units.
 - The appliance is not intended for use by unattended young children or infirm persons. Impairment of bodily functions and harm to health may result.
 - Children should be supervised to ensure that they do not play with the unit or its remote controller. Accidental operation by a child may result in impairment of bodily functions and harm health.
 - Do not place flammable items, such as spray cans, within 1m of the air outlet.
The spray cans may explode as a result of hot air from the indoor or outdoor units.
 - Be careful not to let pets urinate on the air conditioner. Urination on the air conditioner may result in electric shocks or fire.
 - Do not sit or hang on the panel. The panel may fall, and injury or product malfunctioning may result.
 - Do not sway the panel. The panel may hit people or objects, and injury or property damage may result.
 - Do not let children play around the panel. Injury or property damage may result.
 - Do not pull the wires. The wires may be broken and the panel may fall, and injury or property damage may result.
 - Do not locate obstacles in the route. The panel may fall, and injury or property damage may result.
 - Do not bend or damage the wires. The wires may be broken and the panel may fall, and injury or property damage may result.
 - Do not wash the air conditioner with water, as this may result in electric shocks or fire.
 - Do not place water containers (vases, etc.) above the unit, as this may result in electric shocks or fire hazards if they should topple over.
 - Do not put objects on the panel, or otherwise production malfunctioning may result.
 - Do not use an unstable stand at the time of operating or maintaining the air conditioner, or otherwise you may topple over or injure yourself.
 - Locate the remote controller in places out of reach of children. The wrong operation of the remote controller may result in injury.
-
- To avoid oxygen depletion, ensure that the room is adequately ventilated if equipment such as a burner is used together with the air conditioner.
 - Before cleaning, be sure to stop unit operation and turn off the circuit breaker. Otherwise, an electric shock and injury may result.
 - Only connect the air conditioner to the specified power supply circuit. Power supplies other than the one specified may result in electric shocks, overheating and fires.
 - Arrange the drain hose to ensure smooth drainage. Imperfect drainage may cause wetting of the building, furniture, etc.
 - Do not place objects in direct proximity of the outdoor unit and do not let leaves and other debris accumulate around the unit. Leaves are a hotbed for small animals which can enter the unit. Once inside the unit, such animals can cause malfunctions, smoke or fire if they come into contact with electrical parts.
 - Do not place objects around the indoor unit.
Doing so may have an adverse influence on the performance, product quality, and life of the air conditioner.



Installation site

- To install the air conditioner in the following types of environments, consult your dealer.
 - Places with an oily environment or where steam or soot occurs.
 - Salty environments such as coastal areas.
 - Places where sulphide gas occurs such as hot springs.
 - Places where snow may block the outdoor unit.
- Be sure to follow the instructions below.
 - The indoor unit is at least 1m away from any television or radio set (unit may cause interference with the picture or sound).
 - The drain from the outdoor unit must be discharged to a place of good drainage.

Consider nuisance to your neighbours from noises

- For installation, choose a place as described below.
 - A place solid enough to bear the weight of the unit and which does not amplify the operation noise or vibration.
 - A place from where the air discharged from the outdoor unit or the operation noise will not annoy your neighbours.

Electrical work

- For the power supply, be sure to use a separate power circuit dedicated to the air conditioner.

System relocation

- Relocating the air conditioner requires specialized knowledge and skills. Please consult your dealer if relocation is necessary for moving or remodelling.

Name of Parts

Indoor Unit

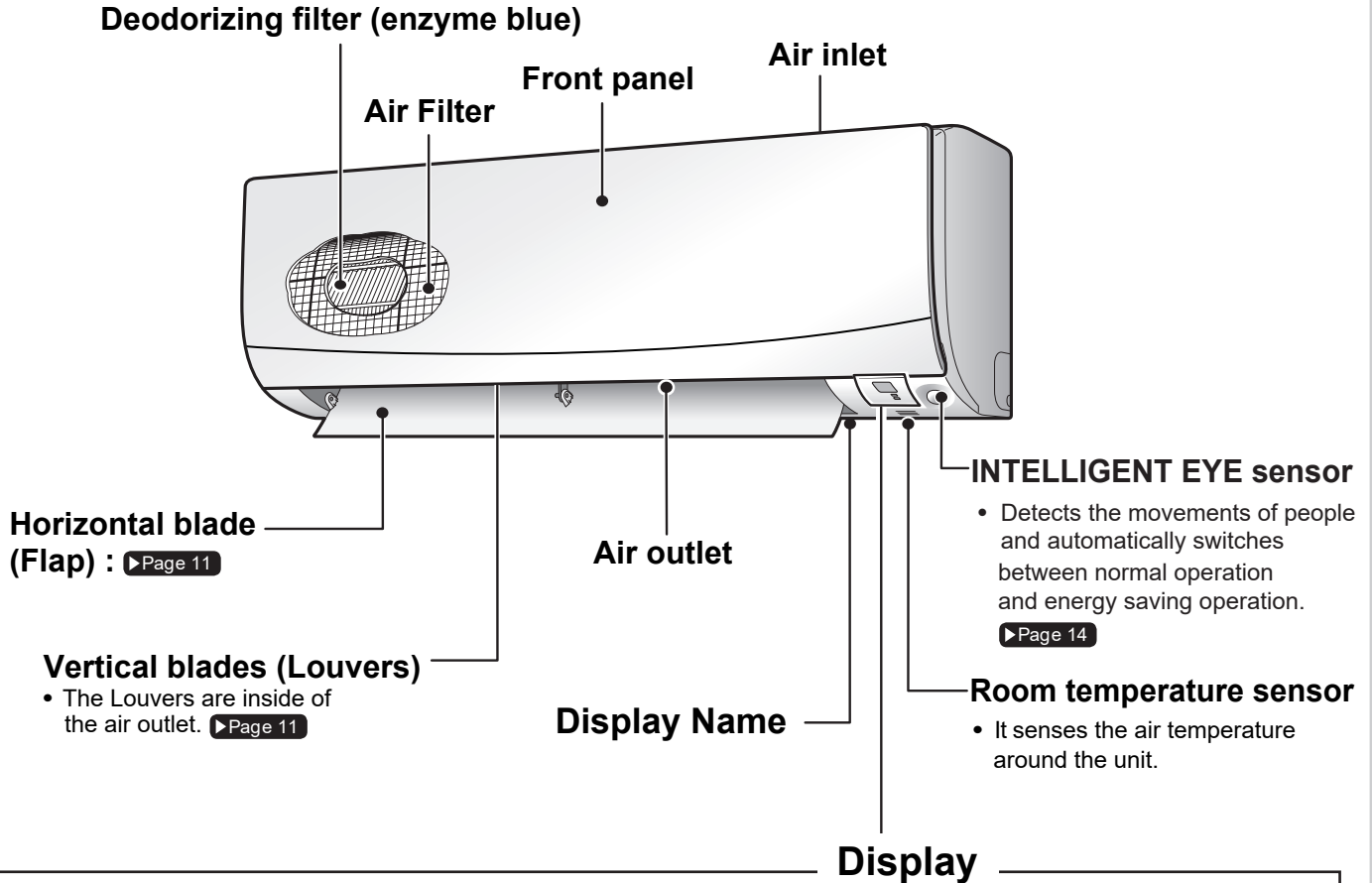

Display

Signal receiver

- It receives signals from the remote controller.
- When the unit receives a signal, you will hear a short beep.
 - Operation start beep-beep
 - Settings changed beep
 - Operation stop beeeeeeep

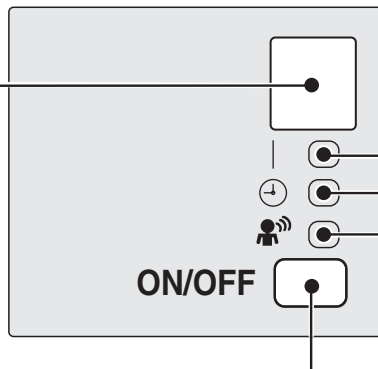

Indoor Unit ON/OFF switch

- Push this switch once to start operation. Push once again to stop it.
- The operation mode refer to the following table.

| Mode | Temperature setting | Airflow rate |
|------|---------------------|--------------|
| AUTO | 25.0°C | AUTO |

- This switch can be used when the remote controller is missing.

■ Open the front panel

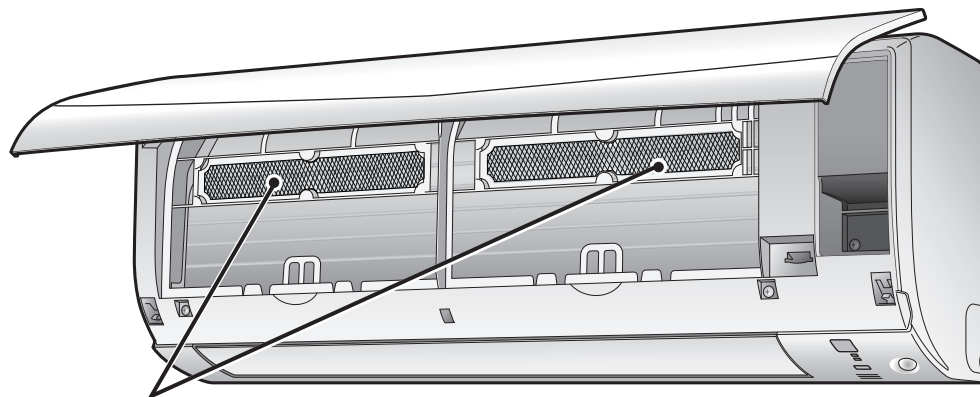

Deodorizing filter
(enzyme blue)

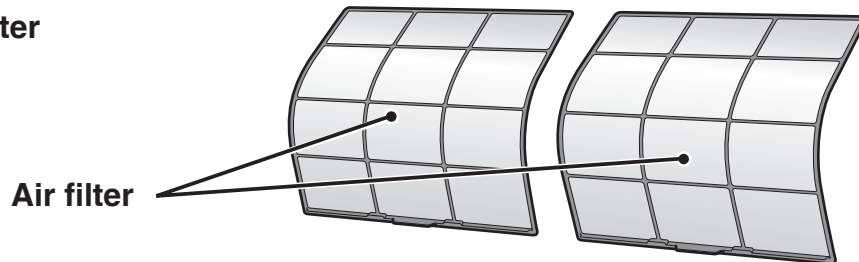

Outdoor Unit

■ For 25/35 class

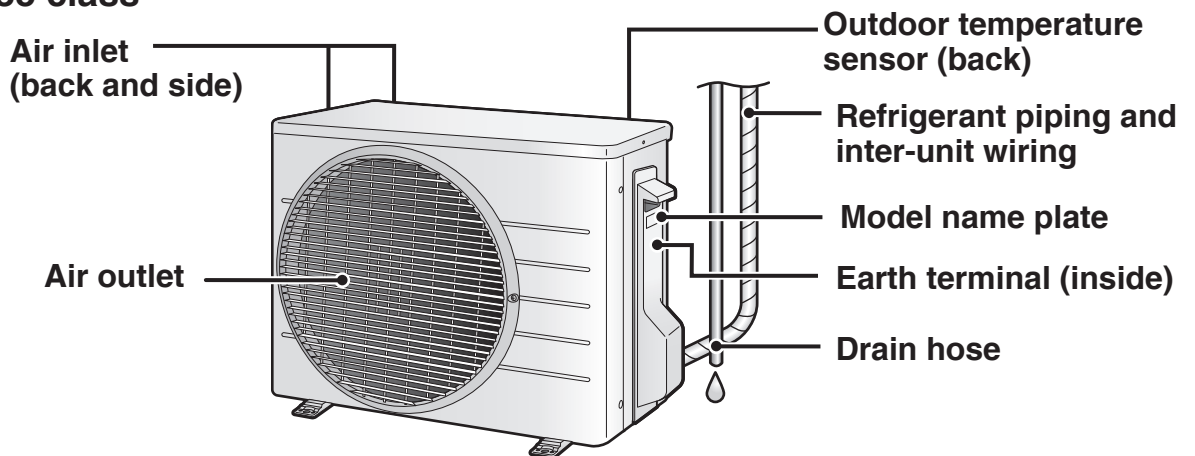

■ For 50 class

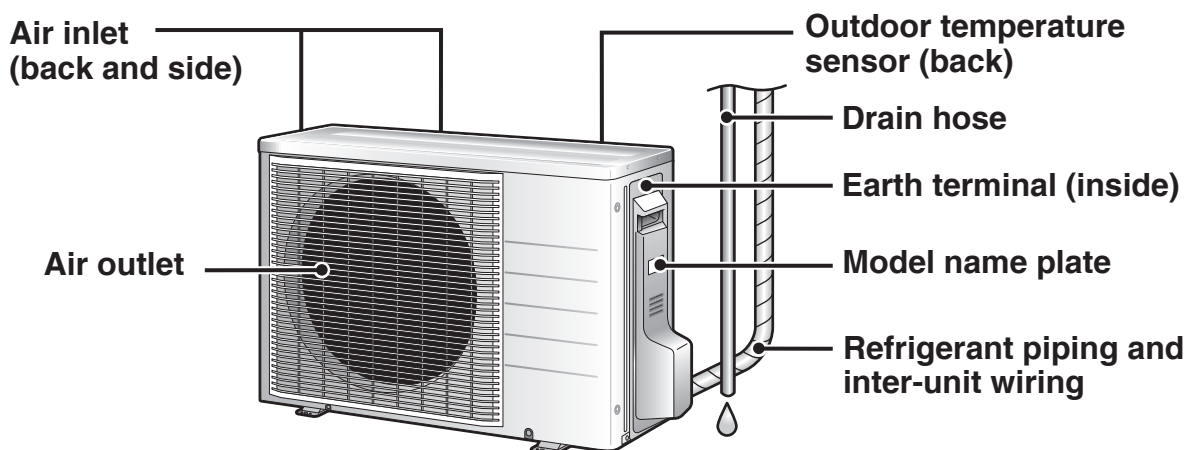

Name of Parts

Remote Controller

Signal transmitter

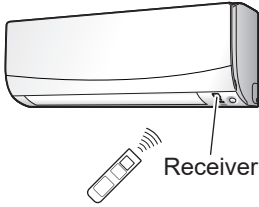

- To use the remote controller, aim the transmitter at the indoor unit. If there is anything to block signals between the unit and the remote controller, such as a curtain, the unit will not receive signals.
- Do not drop the remote controller.
- Do not get it wet.
- The maximum distance for communication is approx. 7m.

Direct operation buttons

- It start operation of the selected mode. (AUTO/DRY/COOL/HEAT/FAN ONLY)

TEMPERATURE adjustment buttons

- It changes the temperature setting.

SENSOR button

- INTELLIGENT EYE operation.

QUIET button

- OUTDOOR UNIT QUITE operation.

OFF TIMER button (Night set mode)

ON TIMER button

Display (LCD)

- It displays the current settings. (In this illustration, each section is shown with its displays on for the purpose of explanation.)

OFF button

- Press this button to stop operation.

FAN setting button

- It selects the airflow rate setting.

ECONO button

- ECONO operation.

POWERFUL button

- POWERFUL operation.

SWING button

- Adjusting airflow direction.

COMFORT AIRFLOW button

- COMFORT AIRFLOW operation.

TIMER CANCEL button

- It cancels the timer setting.

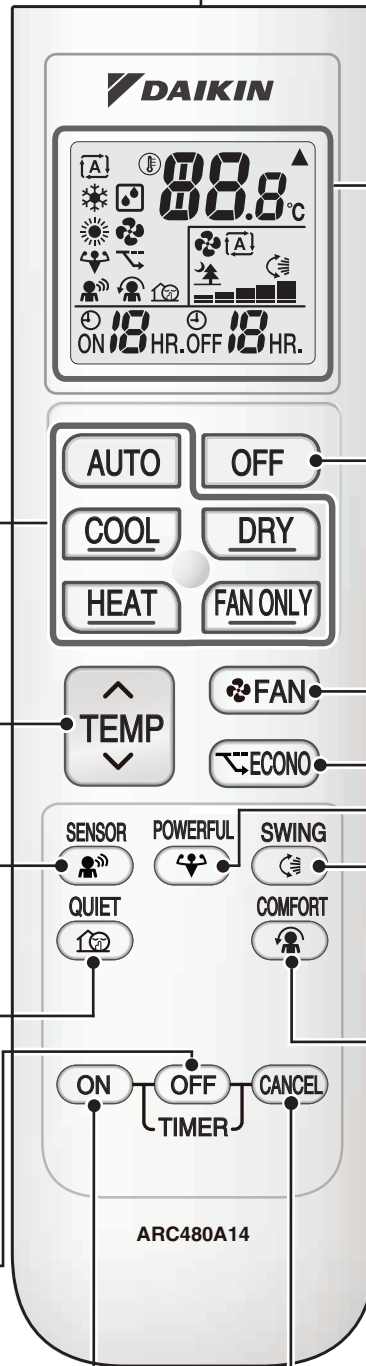

Model ARC480A14

Preparation before Operation

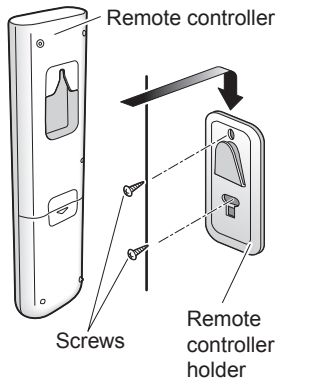
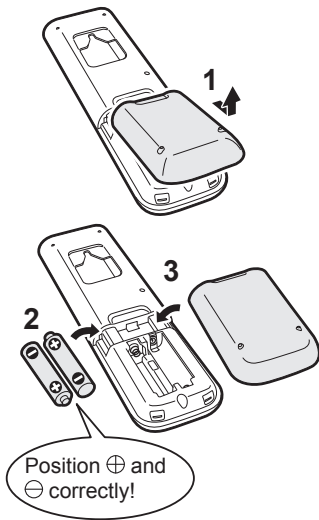

■ To set the batteries

1. Slide the back cover to take it off.
2. Set two dry batteries AAA.LR03 (alkaline).
3. Set the back cover as before.

■ To fix the remote controller holder on the wall

1. Choose a place from where the signals can reach the unit.
2. Fix the holder to a wall, a pillar, or similar location with the screws supplied with the accessory set.
3. Place the remote controller in the remote controller holder.

■ Turn the breaker on

- After the power is turned on, the flaps of the indoor unit opens and closes once to set the reference position.

NOTE

■ Notes on batteries

- When replacing the batteries, use batteries of the same type, and replace both old batteries together.
- When the system is not used for a long time, take the batteries off.
- The batteries will last for approx. 1 year. If the remote controller display begins to fade and the degradation of reception performance occurs within a year, however, replace both batteries with new, size AAA.LR03 (alkaline).
- The attached batteries are provided for the initial use of the system.
The usable period of the batteries may be short depending on the manufactured date of the air conditioner.

■ Low batteries alert

- To prevent remote controller from deteriorate batteries. When batteries seem to be dying (battery voltage lower).
The LCD will blink and the remote controller will stop all operations except to turn off the air conditioner.
To operate remote controller again, replace all the batteries with the new, size AAA. LR03 (Alkaline).

■ Notes on remote controller

- Never expose the remote controller to direct sunlight.
- Dust on the signal transmitter or receiver will reduce the sensitivity. Wipe off dust with soft cloth.
- Signal communication may be disabled if an electronic-starter-type fluorescent lamp (such as inverter-type lamps) is in the room. Consult the shop if that is the case.
- If the remote controller signals happen to operate another appliance, move that appliance to somewhere else, or consult the service shop.



AUTO · DRY · COOL · HEAT · FAN ONLY Operation

The air conditioner operates in the user selected operation mode.



■ To start operation

Press button of your desired operation mode.

AUTO operation

Press **AUTO** button. “**A**” appears on the LCD.

COOL operation

Press **COOL** button. “**❄**” appears on the LCD.

DRY operation

Press **DRY** button. “**☁**” appears on the LCD.

HEAT operation

Press **HEAT** button. “**☀**” appears on the LCD.

FAN ONLY operation

Press **FAN ONLY** button. “**🌀**” appears on the LCD.

- The OPERATION lamp lights green.

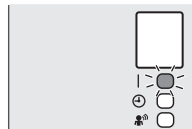

Display

- Operation mode can be change while operating by press your desired operation mode button.

■ To stop operation

Press **OFF**

- The OPERATION lamp goes off.

NOTE

| MODE | Notes on each operation mode |
|----------|---|
| HEAT | <ul style="list-style-type: none"> • Since this air conditioner heats the room by taking heat from outdoor air to indoors, the heating capacity becomes smaller in lower outdoor temperatures. If the heating effect is insufficient, it is recommended to use another heating appliance in combination with the air conditioner. • The heat pump system heats the room by circulating hot air around all parts of the room. After the start of HEAT operation, it takes some time before the room gets warmer. |
| COOL | <ul style="list-style-type: none"> • This air conditioner cools the room by releasing the heat in the room outside. Therefore, the cooling performance of the air conditioner may be decrease if the outdoor temperature is high. |
| DRY | <ul style="list-style-type: none"> • The computer chip works to rid the room of humidity while maintaining the temperature as much as possible. It automatically controls temperature and airflow rate, so manual adjustment of these functions is unavailable. |
| AUTO | <ul style="list-style-type: none"> • In AUTO operation, the system selects an appropriate operation mode (COOL or HEAT) based on the room and outside temperatures and starts the operation. • The system automatically reselects setting at a regular interval to bring the room temperature to user-setting level. |
| FAN ONLY | <ul style="list-style-type: none"> • This mode is valid for fan only. |

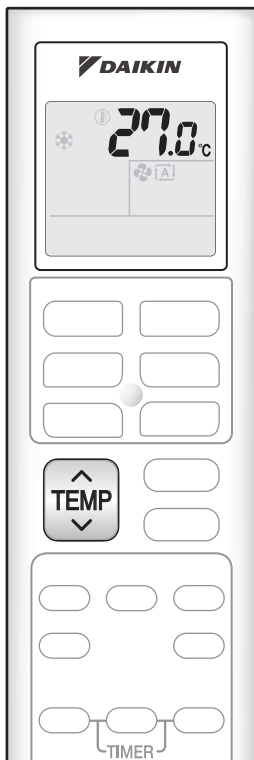

■ To change the temperature setting

Press  .

- The displayed items on the LCD will change whenever either one of the buttons is pressed.

| COOL operation | HEAT operation | AUTO operation | DRY or FAN ONLY operation |
|---|----------------|----------------|---|
| 18.0-32.0°C | 10.0-30.0°C | 18.0-30.0°C | The temperature setting is not available. |
| Press ▲ to raise the temperature and press ▼ to lower the temperature 0.5°C each press. | | | |

■ Operating conditions

■ Recommended temperature setting

- For cooling: 26.0-28.0°C
- For heating: 20.0-24.0°C

■ Tips for saving energy

- Be careful not to cool (heat) the room too much.
Keeping the temperature setting at a moderate level helps save energy.
- Cover windows with a blind or a curtain.
Blocking sunlight and air from outdoors increases the cooling (heating) effect.
- Clogged air filters cause inefficient operation and waste energy. Clean them once in about every 2 weeks.

■ Notes on the operating conditions

- The air conditioner always consumes a small amount of electricity even while it is not operating.
- If you are not going to use the air conditioner for a long period, for example in spring or autumn, turn the breaker off.
- Use the air conditioner in the following conditions.

| MODE | Operating conditions | If operation is continued out of this range |
|------|--|--|
| COOL | Outdoor temperature : -10.0 ~ 46.0°C Indoor temperature : 18.0-32.0°C Indoor humidity : 80% max. | <ul style="list-style-type: none"> • A safety device may work to stop the operation. • Condensation may occur on the indoor unit and drip. |
| HEAT | Outdoor temperature : -15.0 ~ 24.0°C Indoor temperature : 10.0-30.0°C | <ul style="list-style-type: none"> • A safety device may work to stop the operation. |
| DRY | Outdoor temperature : -10.0 ~ 46.0°C Indoor temperature : 18.0-32.0°C Indoor humidity : 80% max. | <ul style="list-style-type: none"> • A safety device may work to stop the operation. • Condensation may occur on the indoor unit and drip. |

- Operation outside this humidity or temperature range may cause a safety device to disable the system.



Adjusting the Airflow Direction

CAUTION

- Always use a remote controller to adjust the angles of the flaps. If you attempt to move the flaps forcibly by hand when they are swinging, the mechanism may be broken.



You can adjust the airflow direction to increase your comfort.

To start auto swing

Upper and lower airflow direction

Press .

- “” appears on the LCD.
- The flaps (horizontal blades) will begin to swing.

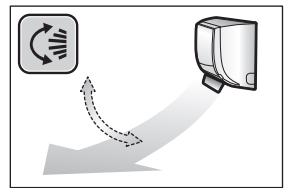

To set the flaps at desired position

- This function is effective while flaps are in auto swing mode.

Press  when the flaps the desired position.

- “” disappears from the LCD.

To adjust the louvers (vertical blades)

Hold the knob and move the louvers.

(You will find a knob on the left-side and the right-side blades.)

- When the unit is installed in the corner of a room, the direction of the louvers should be facing away from the wall.

If they face the wall, the wall will block off the wind, causing the cooling (or heating) efficiency to drop.

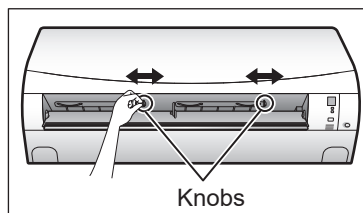

- There is a knob in 2 places.

NOTE

Notes on airflow direction setting

- The movable range of the flaps varies according to the operation mode.
- The flap will stop at the upper position when the airflow rate is changed to low during the up and down swing setting.

Note on airflow rate setting

- At smaller airflow rates, the cooling (heating) effect is also smaller.

Movable range of the flap

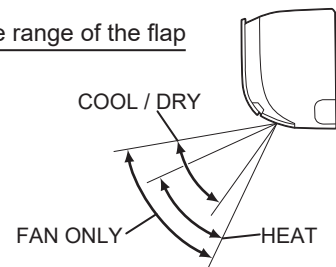



Adjusting the Airflow Rate

You can adjust the airflow rate to increase your comfort.

■ To adjust the airflow rate setting

Press  .

- Each pressing of  change the airflow rate setting in sequence shown below.

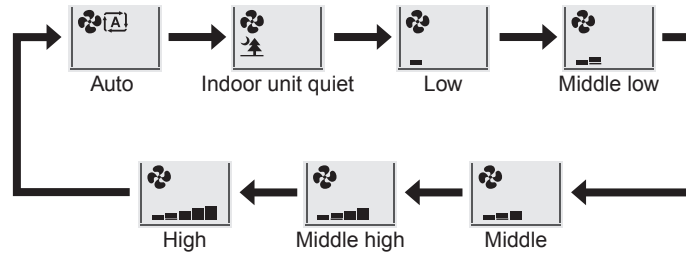

- When the airflow is set to “”, indoor unit quiet operation will start and the noise from the unit will become quieter.
- In indoor unit quiet operation, the airflow rate is set to a weak level.
- If the temperature does not reach the desired point, change the airflow rate setting.
- In DRY mode, the airflow rate setting is not available.





COMFORT AIRFLOW Operation

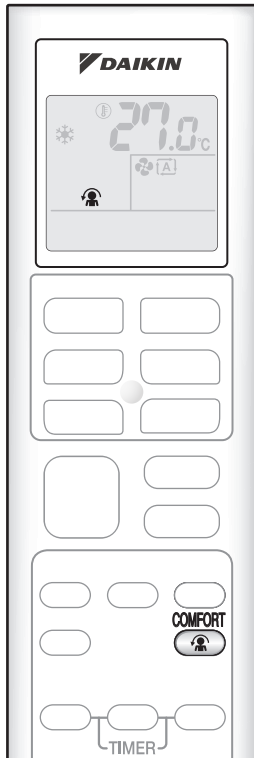

The air direction and flow rate are adjusted so that the air will not blow directly at people in the room.

■ To start COMFORT AIRFLOW operation

Press .

- “” is displayed on the LCD.

| | COOL and DRY operation | HEAT operation | FAN ONLY operation |
|----------------|------------------------|----------------|--------------------|
| Flap direction | Goes up | Goes down | Not available |
| Airflow rate | AUTO | | |

■ To cancel COMFORT AIRFLOW operation

Press  again.

- “” disappears from the LCD.
- The flap will return to the memory position from before COMFORT AIRFLOW operation.

Notes on COMFORT AIRFLOW operation

- The flap position will change, preventing air from blowing directly on the occupants of the room.
- POWERFUL operation and COMFORT AIRFLOW operation cannot be used at the same time. Priority is given to the function of whichever button is pressed last.
- The airflow rate will be set to AUTO. If the upper and lower airflow direction is selected, the COMFORT AIRFLOW operation will be canceled.
- The flow of air will be in the upward direction while in COOL operation and in the downward direction while in HEAT operation, which will provide a comfortable wind that will not come in direct contact with people.

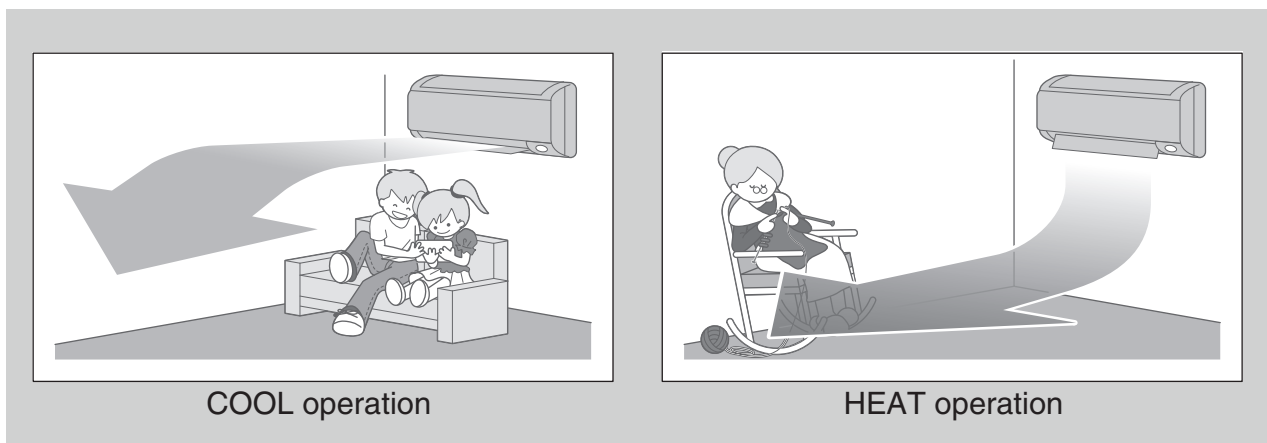



INTELLIGENT EYE Operation

■ INTELLIGENT EYE operation

“INTELLIGENT EYE” is the infrared sensor which detects the human movement.

If no one is in the room for more than 20 minutes, the operation automatically changes to energy saving operation.

The INTELLIGENT EYE sensor according to the following situations.

[Example]

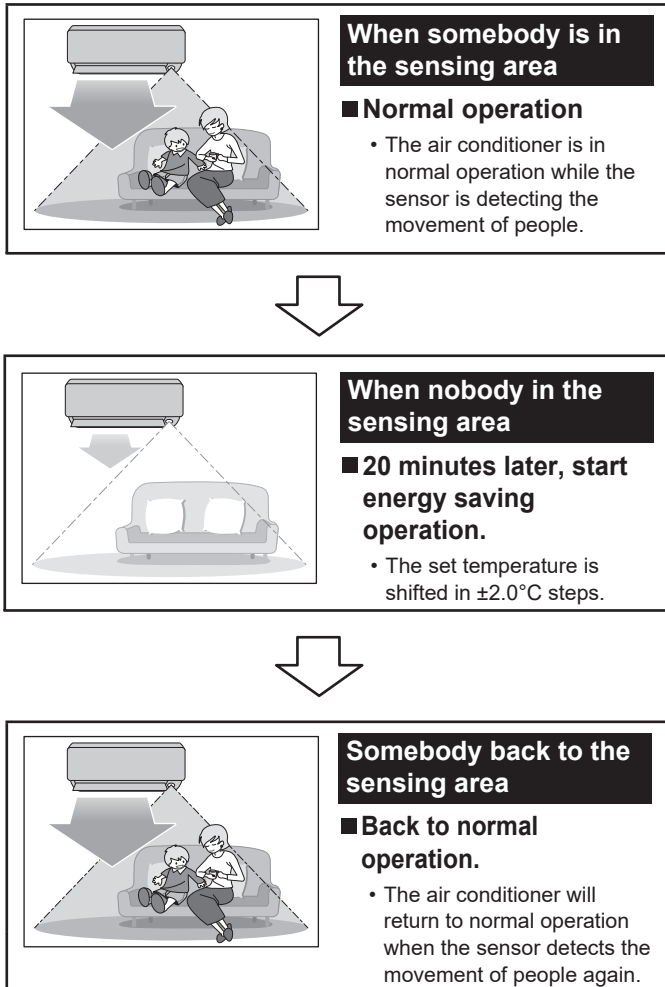

INTELLIGENT EYE operation is useful for energy saving

■ Energy saving operation

- If no presence detected in the room for 20 minutes, the energy saving operation will start.
- This operation changes the temperature -2.0°C in HEAT / $+2.0^{\circ}\text{C}$ in COOL / $+2.0^{\circ}\text{C}$ in DRY operation from set temperature. When the room temperature exceeds 30.0°C , the operation changes the temperature $+1.0^{\circ}\text{C}$ in COOL / $+1.0^{\circ}\text{C}$ in DRY operation from set temperature.
- This operation decreases the airflow rate slightly in FAN operation only.



INTELLIGENT EYE Operation

CAUTION

- Do not place large objects near the INTELLIGENT EYE sensor.
Also keep heating units or humidifiers outside the sensor's detection area. This sensor can detect undesirable objects.
- Do not hit or violently push the INTELLIGENT EYE sensor. This can lead to damage and malfunction.

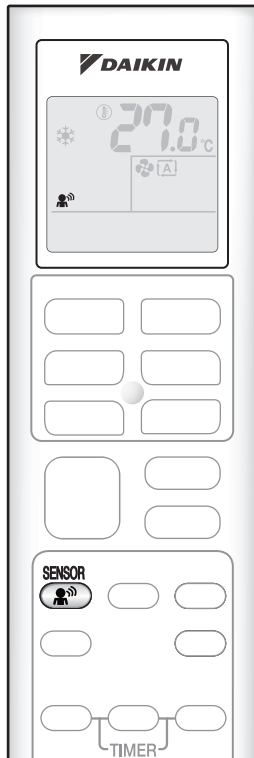

To start intelligent eye operation

Press .

- “” appears on the LCD.
- The INTELLIGENT EYE lamp lights green.

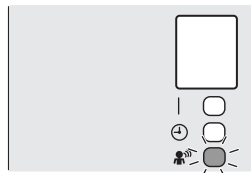

Display

- By selecting “” the air conditioner will be in INTELLIGENT EYE operation.
- The lamp will be lit while human movements are detected.

To cancel operation

Press  again.

- The INTELLIGENT EYE lamp goes off.
- “” disappears from the LCD.

NOTE

Notes on INTELLIGENT EYE operation

- Application range is as follows.

Vertical angle 90°
(Side view)

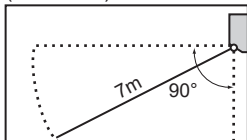

Horizontal angle 110°
(Top view)

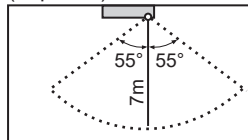

- While the air conditioner is in INTELLIGENT EYE operation, if no people are detected in sensing area within 20 minutes, the air conditioner will go into energy-saving mode with the set temperature shifted by 2.0°C.
The air conditioner may go into energy-saving operation even if there are people in the area.
This may occur depending on the clothes the people are wearing if there are no movements of the people in the area.
- Due to the position of the sensor, people might be exposed to the airflow of the indoor unit if they are close to the front side of the indoor unit.
- Sensor may not detect moving objects further than 7m away. (Check the application range.)
- Sensor detection sensitivity changes according to indoor unit location, the speed of passersby, temperature range, etc.
- The sensor also mistakenly detects pets, sunlight, fluttering curtains and light reflected off of mirrors as passersby.
- INTELLIGENT EYE operation will not go on during POWERFUL operation.
- NIGHT SET mode [▶Page 20](#) will not go on during use of INTELLIGENT EYE operation.



POWERFUL Operation

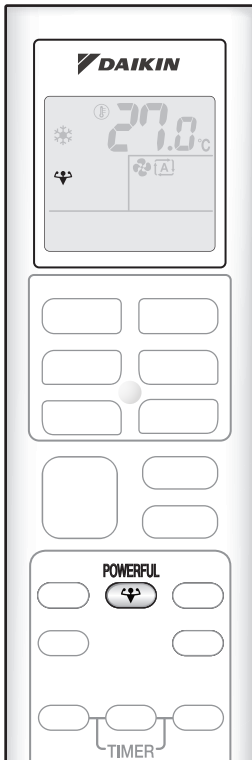

POWERFUL operation quickly maximizes the cooling (heating) effect in any operation modes. You can get the maximum capacity.

■ To start POWERFUL operation

Press  during operation.

- POWERFUL operation ends in 20 minutes. Then the system automatically operates again with the previous settings which were used before POWERFUL operation.
- “” appears on the LCD.

■ To cancel POWERFUL operation

Press  again.

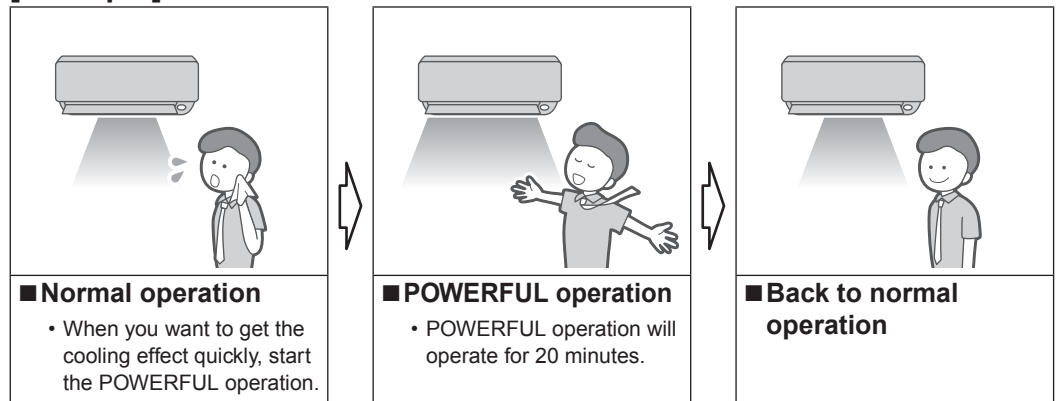

- “” disappears from the LCD.

[Example]



NOTE

■ Notes on POWERFUL operation

- When using POWERFUL operation, there are some functions which are not available.
- POWERFUL operation cannot be used together with ECONO or OUTDOOR UNIT QUIET operation. Priority is given to the function of whichever button is pressed last.
- POWERFUL operation can only be set when the unit is running. Pressing  causes the settings to be canceled, and “” disappears from the LCD.
- POWERFUL operation will not increase the capacity of the air conditioner if the air conditioner is already in operation with its maximum capacity demonstrated.
- **In COOL and HEAT operation**
To maximize the cooling (heating) effect, the capacity of outdoor unit is increased and the airflow rate is fixed to the maximum setting. The temperature and airflow settings are not available.
- **In DRY operation**
The temperature setting is lowered by 2.5°C and the airflow rate is slightly increased.
- **In FAN ONLY operation**
The airflow rate is fixed at the maximum speed.
- **In AUTO operation**
To maximize the cooling (heating) effect, the capacity of outdoor unit is increased and the airflow rate is fixed to the maximum setting. The temperature and airflow settings are not available.



ECONO Operation

■ ECONO operation

ECONO operation is a function which enables efficient operation by limiting the maximum power consumption value.

This function is useful for cases in which attention should be paid to ensure a circuit breaker will not trip when the product runs alongside other appliances.

[Example]

Normal operation



- In case the air conditioner and other appliances which require high power consumption are used at same time, a circuit breaker may trip if the air conditioner operate with its maximum capacity.

ECONO operation

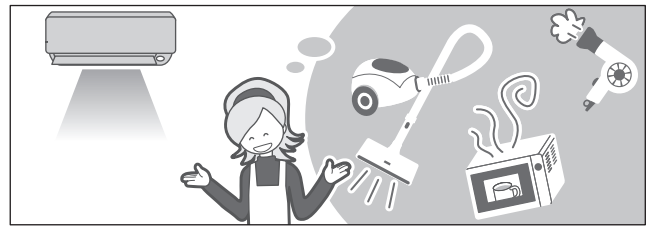

- The maximum power consumption of the air conditioner is limited by using ECONO operation. The circuit breaker will hardly trip even if the air conditioner and other appliances are used at same time.

Running current and power consumption

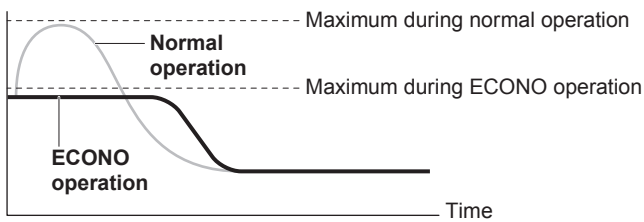

From start up until set temperature is reached

- This diagram is a representation for illustrative purposes only. The maximum running current and power consumption of the air conditioner in ECONO operation vary with the connecting outdoor unit.

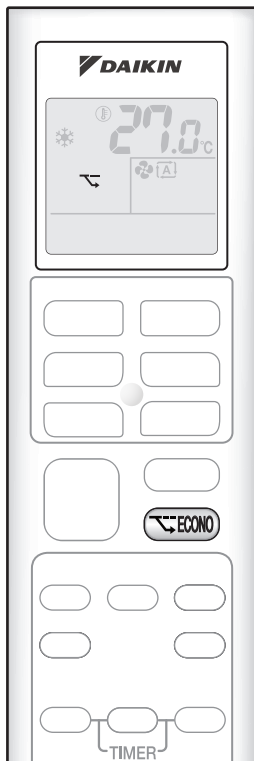

■ To start ECONO operation

Press .

- “” appears on the LCD.



■ To cancel ECONO operation

Press  again.

- “” disappears from the LCD.

NOTE

■ Notes on ECONO operation

- ECONO operation can only be set when the unit is running. Pressing  causes the settings to be canceled, and “” disappears from the LCD.
- ECONO operation is a function which enables efficient operation by limiting the power consumption of the outdoor unit (operating frequency).
- ECONO operation functions in AUTO, COOL, DRY, and HEAT operation.
- POWERFUL and ECONO operation cannot be used at the same time. Priority is given to the function of whichever button is pressed last.
- If the level of power consumption is already low, ECONO operation will not drop the power consumption.



OUTDOOR UNIT QUIET Operation

■ OUTDOOR UNIT QUIET operation

OUTDOOR UNIT QUIET operation lowers the noise level of the outdoor unit by changing the frequency and fan speed on the outdoor unit. This function is convenient during the night.



■ To start operation

Press .

- “” appears on the LCD.

■ To cancel operation

Press  again.

- “” disappears from the LCD.

[Example] Using the OUTDOOR UNIT QUIET operation during the night.

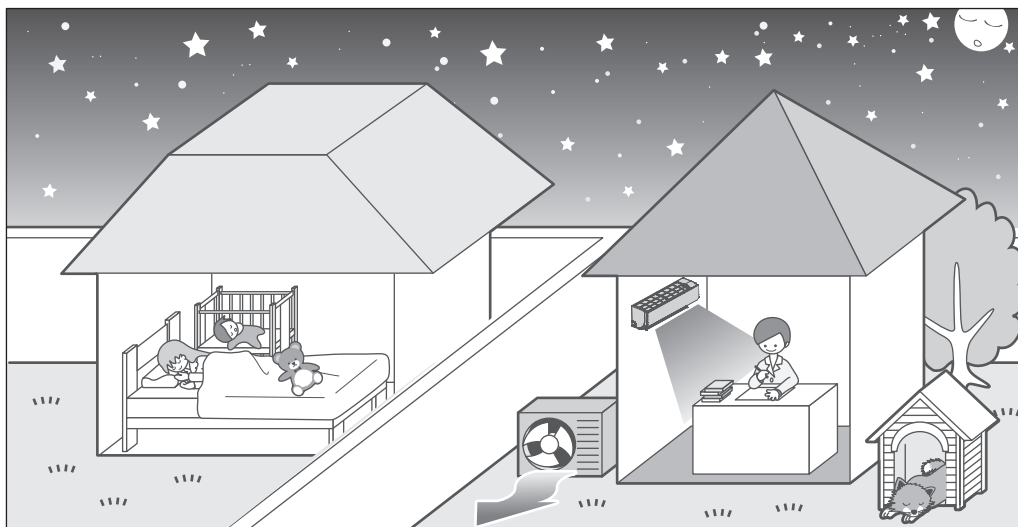

- The noise level of the outdoor unit will be lower. This function is useful when you need to consider the noise for your neighbourhood.

NOTE

■ Notes on OUTDOOR UNIT QUIET operation

- This function is available in COOL, HEAT, and AUTO operation.
This is not available in FAN ONLY and DRY operation.
- POWERFUL operation and OUTDOOR UNIT QUIET operation cannot be used at the same time.
Priority is given to the function of whichever button is pressed last.
- Even the operation is stopped by using the remote controller or the indoor unit ON/OFF switch
when using OUTDOOR UNIT QUIET operation, “” will remain on the remote controller display.
- OUTDOOR UNIT QUIET operation will drop neither the frequency nor fan speed if they have been already dropped low enough.

OFF

OFF TIMER Operation

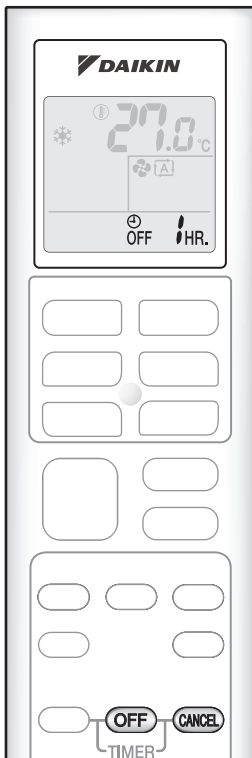

Timer functions are useful for automatically switching the air conditioner on or off at night or in the morning. You can also use OFF TIMER and ON TIMER in combination.

■ To use OFF TIMER operation

1. Press **OFF** .

 • “**OFF** **HR.**” is display on the LCD.

2. Press **OFF** until the time setting reaches the point

- Each pressing of button increases the time setting by 1 hour.
- Setting time can be increase to 12 hours maximum.
- The TIMER lamp lights orange.

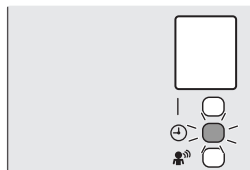

Display

■ To cancel OFF TIMER operation

Press **CANCEL** .

- “**OFF** **HR.**” disappear from the LCD.
- The TIMER lamp goes off.

NOTE

■ Notes on TIMER operation

- When operating the unit via the ON/OFF TIMER, the actual length of operation may vary from the time entered by the user. (Maximum approx. 10 minutes)

■ NIGHT SET mode

- When the OFF TIMER is set, the air conditioner automatically adjusts the temperature setting (0.5°C up in COOL, 2.0°C down in HEAT) to prevent excessive cooling (heating) for your pleasant sleep.

ON

ON TIMER Operation

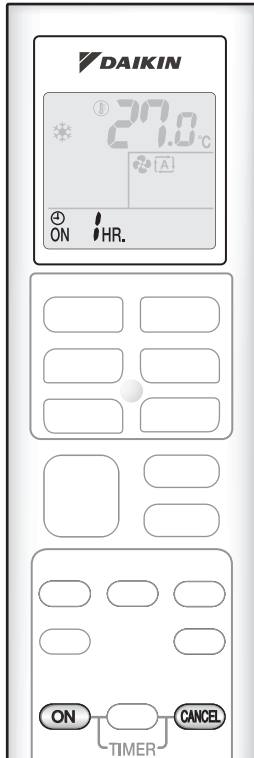

■ To use ON TIMER operation

1. Press **ON**.

 • “  ON  .” is display on the LCD.

2. Press **ON** until the time setting reaches the point you prefer.

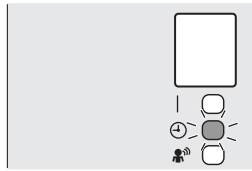

- Each pressing of button increases the time setting by 1 hour.
- Setting time can be increase to 12 hours maximum.
- The TIMER lamp lights orange.



Display

■ To cancel ON TIMER operation

Press **CANCEL**.

- “  ON  .” disappear from the LCD.
- The TIMER lamp goes off.

■ To combine ON TIMER and OFF TIMER

- A sample setting for combining the 2 timers is shown below.

- When setting while unit is operating.

(Example)
 Turn off unit in the next 1 hr.) Combined
 Turn on unit in the next 8 hr. (7 hr. after turn off) → 

- When setting while unit is stopped.

(Example)
 Turn on unit in the next 2 hr.) Combined
 Turn off unit in the next 5 hr. (3 hr. after turn on) → 

NOTE

■ In the following cases, set the timer again.

- After a breaker has turned off.
- After a power failure.
- After replacing batteries in the remote controller.

Care and Cleaning

CAUTION

- Before cleaning, be sure to stop the operation and turn the breaker off.
- Do not touch the aluminium fins of the indoor unit. If you touch those parts, this may cause an injury.

Quick reference

How to open / close the front panel

- Hold the front panel by the panel tabs on the both sides and open it.
- Press the front panel at both sides and the center to close it.

Cleaning parts

Front panel

- Wipe it with a soft damp cloth.
- Only neutral detergent may be used.

If dirty ▶ Page 23



Air filter

- Vacuum dust or wash the filter.

Once every 2 weeks

▶ Page 24

Indoor unit and Remote controller

- Wipe them with a soft cloth.

If dirty

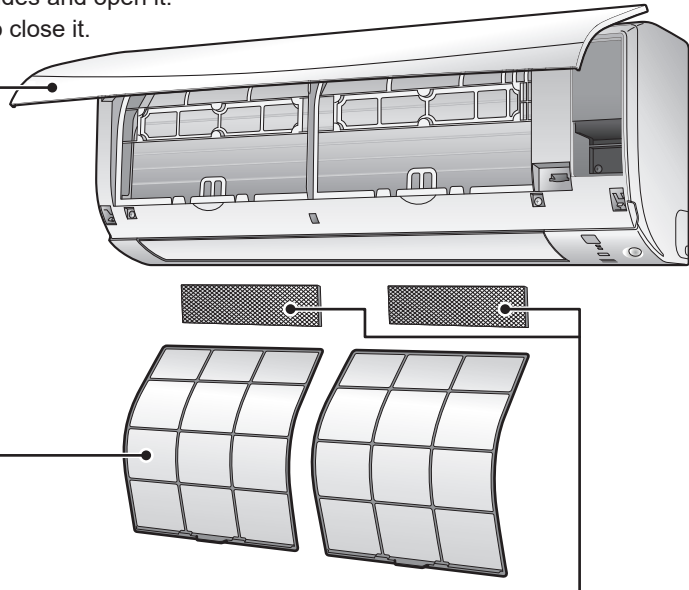

Deodorizing filter (enzyme blue)

To purchase the filters (**Table 1**) or to purchase the another type, contact the dealer where you bought the air conditioner. The method of cleaning and replacement of the filters may differ depending on the model. Refer to the label attached to the separately sold filters themselves.

Table 1

| Item | Part No. |
|---|------------|
| Air quality filter (enzyme blue with PM 2.5) - without frame (set of 2) | BAFP094A43 |
| Deodorizing filter (enzyme blue) - without frame (set of 2) | BAFP094A41 |
| Dust collection filter (PM 2.5) - without frame (set of 2) | BAFP046A41 |
| Titanium apatite deodorizing filter - without frame (set of 2) | KAF970A46 |

Deodorizing filter (enzyme blue), Titanium apatite deodorizing filter.

- Vacuum dust or replace the filter.

[Cleaning]

Once every 6 months

▶ Page 25

[Replacement]

Once every 3 years

▶ Page 25

Air quality filter (enzyme blue with PM 2.5), Dust collection filter (PM 2.5)

- No cleaning is required. Please replace the filter every 6 months. ▶ Page 25

NOTE

For cleaning, do not use the materials as follows.

- Hot water above 40.0°C.
- Benzine, gasoline, thinner, other volatile oils.
- Polishing compound.
- Scrubbing brushes, other hard stuff.



Care and Cleaning

CAUTION

- When removing or attaching the front panel, use a robust and stable stool and watch your steps carefully.
- When removing or attaching the front panel, support the panel securely with hand to prevent it from falling.
- After cleaning, make sure that the front panel is securely fixed.

■ Front panel

1. Remove the front panel.

- Open the front panel.
- Slide the front panel to either the left or right and pulling it toward you. This will disconnect the front panel shaft on one side.

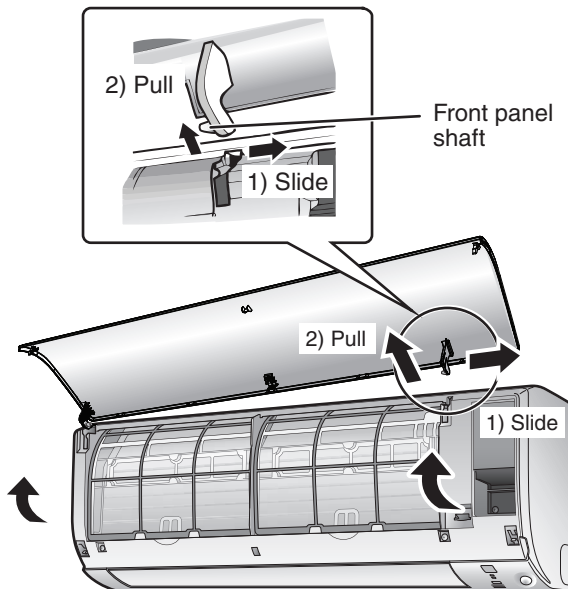

- Disconnect the front panel shaft on the other side in the same manner.

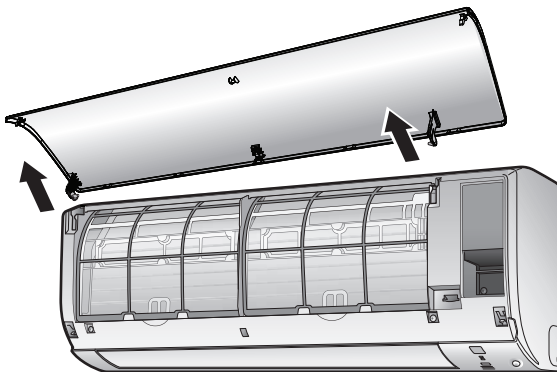

2. Clean the front panel.

- Wipe it lightly with a soft cloth soaked in water or a liquid neutral detergent.
- Wipe it with a dry soft cloth.

3. Attach the front panel.

- Align the front panel shaft on the left and right of the front panel with the slots, then push them all the way in.

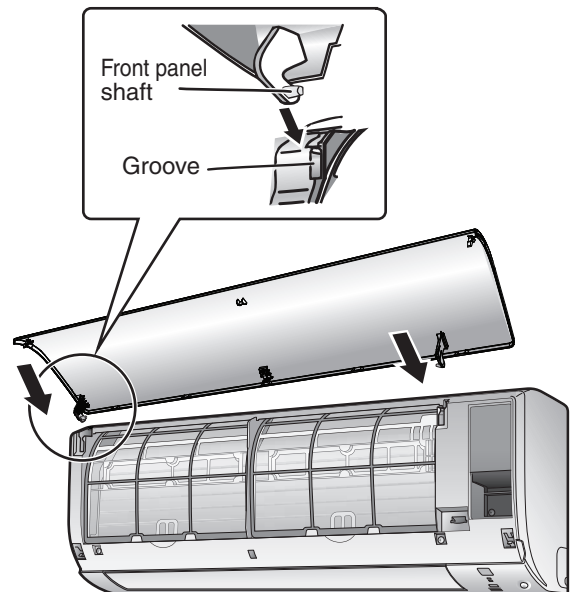

- Close the front panel slowly. (Press the panel at both sides and in the central area.)



CAUTION

- Do not touch the aluminum fins by bare hand at the time of dismantling or mounting the filter.

■ Air filter

1. Pull out the air filters.

- Open the front panel.
- Push a little upwards the filter tab at the center of each air filter, then pull it down.

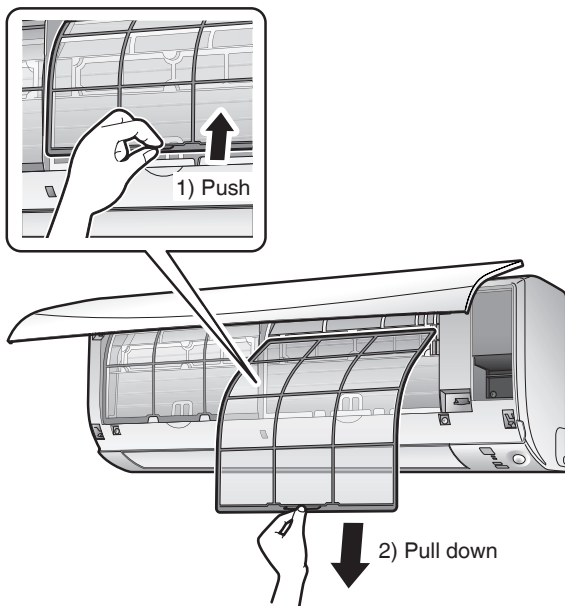

2. Wash the air filters with water or clean them with vacuum cleaner.

- It is recommended to clean the air filters every 2 weeks.

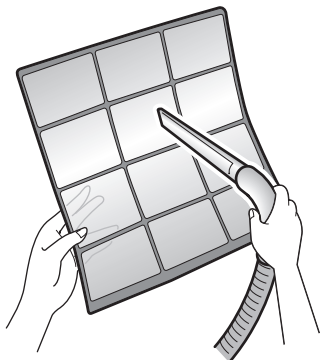

If the dust does not come off easily

- Wash the air filters with neutral detergent thinned with lukewarm water, then dry them up in the shade.



3. Set the filters as they were and close the front panel.

- Press the front panel at both sides and in the central area.

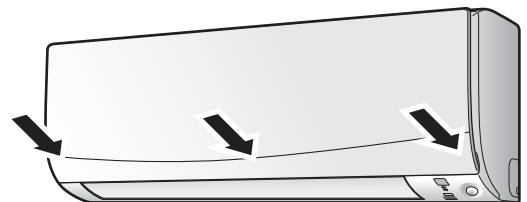

Care and Cleaning

■ Filter (small)

* For the applicable filter type, please refer to [▶Page 22](#).

Attaching

1. Open the front panel and pull out the air filters. [▶Page 24](#)

2. Insert the filter.

- Check that the filters are inserted securely under the tabs.

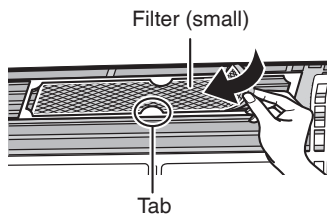

Cleaning and Replacement

1. Open the front panel and pull out the air filters. [▶Page 24](#)

2. Take off the filter.

- Remove the filters from the tabs.

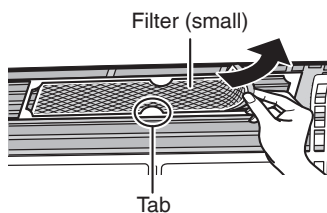

NOTE

- Operation with dirty filters:
 - cannot deodorise the air,
 - cannot clean the air,
 - results in poor heating or cooling,
 - may cause odour.
- Dispose of old filters as non-flammable waste.

3. Clean or replace.

[Cleaning]

● **Deodorizing filter (enzyme blue) : Blue / Titanium apatite deodorizing filter : Blue-Black**

3-1 Vacuum dust, and soak in lukewarm water or water for about 10 to 15 minutes if very dirty.

3-2 After washing, shake off remaining water and let them dry in the shade.

- This filter can be renewed by washing it with water once **every 6 months** and we recommend replacing it once **every 3 years**.
- Do not wring out the filter when removing water from it.

● **Air quality filter (enzyme blue with PM 2.5) : Blue-White / Dust collection filter (PM 2.5) : White**

- Do not wash the filters as this will reduce their efficiency.
- It is recommended to replace it once **every 6 months**.

[Replacement]

Remove the filter from the filter frame and prepare a new one.

- When attaching the filter, check that the filter is properly set in the tabs.

4. Set the filters as they were and close the front panel.

- Press the front panel at both sides and the center.

■ Check the units

- Check that the base, stand and other fittings of the outdoor unit are not decayed or corroded.
- Check that nothing blocks the air inlets and the outlets of the indoor unit and the outdoor unit.
- Check that the drain comes smoothly out of the drain hose during COOL or DRY operation.
 - If no drain water is seen, water may be leaking from the indoor unit. Stop operation and consult the service shop if this is the case.

■ Before a long idle period

1. Operate the FAN only for several hours on a fine day to dry out the inside.

- Press **FAN ONLY** to start “ Fan only ” operation.

2. After operation stops, turn off the breaker for the room air conditioner.

3. Clean the air filters and set them again.

4. Take out batteries from the remote controller.

■ We recommend periodical maintenance

- In certain operating conditions, the inside of the air conditioner may get foul after several seasons of use, resulting in poor performance. It is recommended to have periodical maintenance by a specialist aside from regular cleaning by the user.
- For specialist maintenance, contact the service shop where you bought the air conditioner.
- The maintenance cost must be in responsible of user.

Troubleshooting

■ These cases are not troubles.

- The following cases are not air conditioner troubles but have some reasons. You may just continue using it.

Indoor unit

The flaps do not start swing immediately.

- The air conditioner is adjusting the flap position. The flap will start moving soon.

The air conditioner stops generating airflow during HEAT operation.

- Once the set temperature is reached, the airflow rate is reduced and operation stopped in order to avoid generating a cool airflow. Operation will resume automatically when the indoor temperature falls.

The HEAT operation stops suddenly and a flowing sound is heard.

- The outdoor unit is taking away the frost. The HEAT operation starts after the frost on the outdoor unit is removed. You should wait for about 4 to 12 minutes.

Operation does not start soon.

- **When "ON/OFF" button was pressed soon after operation was stopped.**
- **When the mode was reselected.**
 - This is to protect the air conditioner. You should wait for about 3 minutes.

Outdoor unit

The outdoor unit emits water or steam.

- **In HEAT operation**
 - The frost on the outdoor unit melts into water or steam when the air conditioner is in defrost operation.
- **In COOL or DRY operation**
 - Moisture in the air condenses into water on the cool surface of outdoor unit piping and drips.

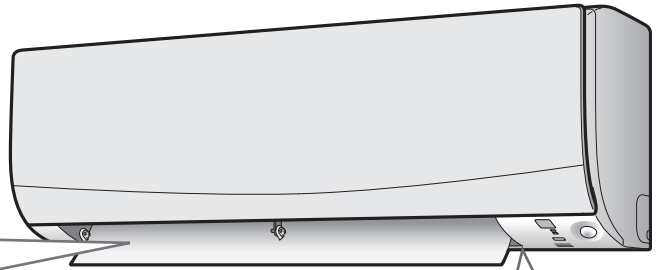

A sound is heard.

■ A sound like a flow of water

- This sound is generated because the refrigerant in the air conditioner is flowing.
- This is a pumping sound of the water in the air conditioner and heard when the water is pumped out from the air conditioner in cooling or drying operation.
- The refrigerant flows in the air conditioner even if the air conditioner is not working when the indoor units in other rooms are in operation.

■ Blowing sound

- This sound is generated when the flow of the refrigerant in the air conditioner is switching.

■ Ticking sound

- This sound is generated when the size of the air conditioner slightly expands or shrinks as a result of temperature changes.

■ Whistling sound

- This sound is generated when refrigerant flows during defrosting operation.

■ Clicking sound during operation or idle time

- This sound is generated when the refrigerant control valves or the electrical parts operate.

■ Clipping sound

- This sound is heard from the inside of the air conditioner when the exhaust fan is activated while the room doors are closed. Open the window or turn off the exhaust fan.

■ Rotating machinery causes sound

- Sound is heard when the vertical swing flaps and the horizontal swing flaps move.
- When the air conditioner is operating in a quiet environment and the airflow rate of the indoor unit is set to Quiet Mode or Low Mode, the motion of the swing flaps may cause sound.

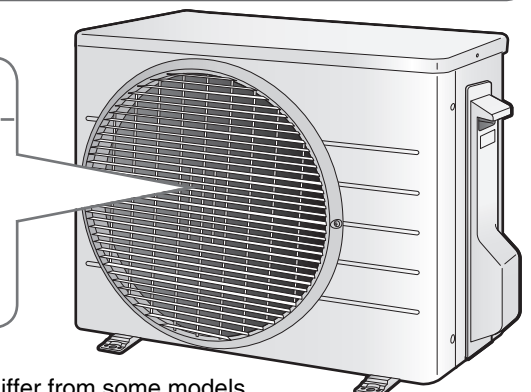

* The appearance of the outdoor unit may differ from some models.

- Troubleshooting measures are classified into the following two types on a remedial basis.
Take an appropriate measure according to the symptom.



Not trouble

- These cases are not troubles.



Check

- Please check again before calling service shop.

The air conditioner does not operate.

(OPERATION lamp is off.)

- Hasn't a breaker turned off or a fuse blown?
- Isn't it a power failure?
- Are batteries set in the remote controller?
- Is the timer setting correct?

(OPERATION lamp blinks)

- Turn off the power with the circuit breaker and restart operation with the remote controller.
If the OPERATION lamp is still blinking, check the error code and consult your dealer.



Operation stopped suddenly. (OPERATION lamp blinks.)

- Are the air filters clean?
Clean the air filters.
- Is there anything to block the air inlet or the outlet of the indoor and the outdoor units?
- Turn the breaker off and take all obstacles away. Then turn it on again and try operating the air conditioner with the remote controller. If the lamp still flashes, call the service shop where you bought the air conditioner.



Operation stopped suddenly. (OPERATION lamp is on.)

- For system protection, the air conditioner may stop operating on a sudden large voltage fluctuation. It automatically resumes operation in about 3 minutes.



Cooling (Heating) effect is poor.

- Are the air filters clean?
- Is there anything to block the air inlet or the outlet of the indoor and the outdoor units?
- Is the temperature setting appropriate?
- Are the windows and doors closed?
- Are the airflow rate and the airflow direction set appropriately?
- Are outdoor ambient temperature not in operation range?
- Is the air conditioner in ECONO operation or OUTDOOR UNIT QUIET operation?



Mist comes out of the indoor unit.

- This happens when the air in the room is cooled into mist by the cold airflow during COOL operation.



An abnormal functioning happens during operation.

- The air conditioner may malfunction with lightning or radio waves. Turn the breaker off, turn it on again and try operating the air conditioner with the remote controller.



Troubleshooting

Hot air does not flow out soon after the start of HEAT operation.

- The air conditioner is warming up. You should wait for 1 to 4 minutes. (The system is designed to start discharging air only after it has reached a certain temperature.)



The ON/OFF TIMER does not operate according to the settings.

- Check if the ON/OFF TIMER correct the actual length of timer can be differ from user setted time for approx. 10 minutes.



Remote controller does not work properly.

- **No remote controller signals are displayed.**
- **The remote controller sensitivity is low.**
- **The LCD blinks and the remote controller stop operate.**
 - The batteries are drying and the remote controller is malfunctioning. Replace all the batteries with new, size AAA.LR03 (alkaline). For details, refer to set the batteries of this manual. [▶Page 8](#)
- **The unit does not receive signals from remote controller or has a limited operating range.**
 - Signal communication may be disabled if an electronic-starter-type fluorescent lamp (such as inverter-type lamps) is in the room. Consult your dealer if that is in this case.
 - The remote controller may not function correctly if the transmitter is exposed to direct sunlight.
- **Other electronic devices start operating.**
 - If the remote controller activates other electronic devices, move them away or consult your dealer.



The outdoor fan rotates while the air conditioner is not in operation.

- **After operation is stopped**
 - The outdoor fan continues rotating for another 60 seconds for system protection.
- **While the air conditioner is not in operation**
 - When the outdoor temperature is very high, the outdoor fan starts rotating for system protection.



The indoor unit gives out odour.

- This happens when smells of the room, furniture, or cigarettes are absorbed into the unit and discharged with the airflow.
(If this happens, we recommend you to have the indoor unit washed by a technician. Consult the service shop where you bought the air conditioner.)



■ Call the service shop immediately

WARNING

- **When an abnormality (such as a burning smell) occurs, stop operation and turn the breaker off.**
 - Continued operation in an abnormal condition may result in troubles, electric shocks or fire.
 - Consult the service shop where you bought the air conditioner.
- **Do not attempt to repair or modify the air conditioner by yourself.**
 - Incorrect work may result in electric shocks or fire.
 - Consult the service shop where you bought the air conditioner.

If one of the following symptoms takes place, call the service shop immediately.

- The power cord is abnormally hot or damaged.
- An abnormal sound is heard during operation.
- The safety breaker, a fuse, or the earth leakage breaker cuts off the operation frequently.
- A switch or a button often fails to work properly.
- There is a burning smell.
- Water leaks from the indoor unit.

Turn the breaker off and call the service shop.



■ After a power failure

- The air conditioner automatically resumes operation in about 3 minutes. You should just wait for a while.

■ Lightning

- If lightning may strike the neighbouring area, stop operation and turn the breaker off for system protection.

■ Disposal requirements

- Dismantling of the unit, treatment of the refrigerant, oil and eventual other parts, should be done in accordance with the relevant local and national regulations.

Troubleshooting



■ Fault diagnosis by remote controller

- In case the air conditioner is malfunctioning, you can check the error code via the remote controller before consulting with service personnel and informing them of the malfunction code.

1. When **CANCEL is held down for 5 seconds, a “00” indication blinks on the temperature display section.**

2. Press **CANCEL repeatedly until a continuous beep is produced.**

- The code indication changes as shown below, and notifies with a long beep.

| | CODE | MEANING |
|--------------|---|--|
| SYSTEM | 00 | NORMAL |
| | UA | INDOOR-OUTDOOR UNIT COMBINATION FAULT |
| | U0 | REFRIGERANT SHORTAGE |
| | U2 | DROP VOLTAGE OR MAIN CIRCUIT OVERVOLTAGE |
| | U4 | FAILURE OF TRANSMISSION (BETWEEN INDOOR UNIT AND OUTDOOR UNIT) |
| INDOOR UNIT | A1 | INDOOR PCB DEFECTIVENESS |
| | A5 | HIGH PRESSURE CONTROL OR FREEZE-UP PROTECTOR |
| | A6 | FAN MOTOR FAULT |
| | C4 | FAULTY HEAT EXCHANGER TEMPERATURE SENSOR |
| | C9 | FAULTY SUCTION AIR TEMPERATURE SENSOR |
| OUTDOOR UNIT | EA | COOLING-HEATING SWITCHING ERROR |
| | E1 | CIRCUIT BOARD FAULT |
| | E5 | OL STARTED |
| | E6 | FAULTY COMPRESSOR START UP |
| | E7 | DC FAN MOTOR FAULT |
| | E8 | OVERCURRENT INPUT |
| | F3 | HIGH TEMPERATURE DISCHARGE PIPE CONTROL |
| | F6 | HIGH PRESSURE CONTROL (IN COOLING) |
| | H0 | SENSOR FAULT |
| | H6 | OPERATION HALT DUE TO FAULTY POSITION DETECTION SENSOR |
| | H8 | DC CURRENT SENSOR FAULT |
| | H9 | FAULTY SUCTION AIR TEMPERATURE SENSOR |
| | J3 | FAULTY DISCHARGE PIPE TEMPERATURE SENSOR |
| | J6 | FAULTY HEAT EXCHANGER TEMPERATURE SENSOR |
| | L3 | ELECTRICAL PARTS HEAT FAULT |
| L4 | HIGH TEMPERATURE AT INVERTER CIRCUIT HEATSINK | |
| L5 | OUTPUT OVERCURRENT | |
| P4 | FAULTY INVERTER CIRCUIT HEATSINK TEMPERATURE SENSOR | |

NOTE

- A short beep and two consecutive beeps indicate non-corresponding codes.
- To cancel the code display, hold **CANCEL** for 5 seconds. The code display also cancel itself if the button is not pressed for 1 minute.

MEMO

A large, empty white rectangular area with rounded corners, intended for writing a memo. It occupies the majority of the page below the 'MEMO' header.

MEMO

A large, empty white rectangular area with rounded corners, intended for writing a memo. It occupies the majority of the page below the 'MEMO' header.

MEMO

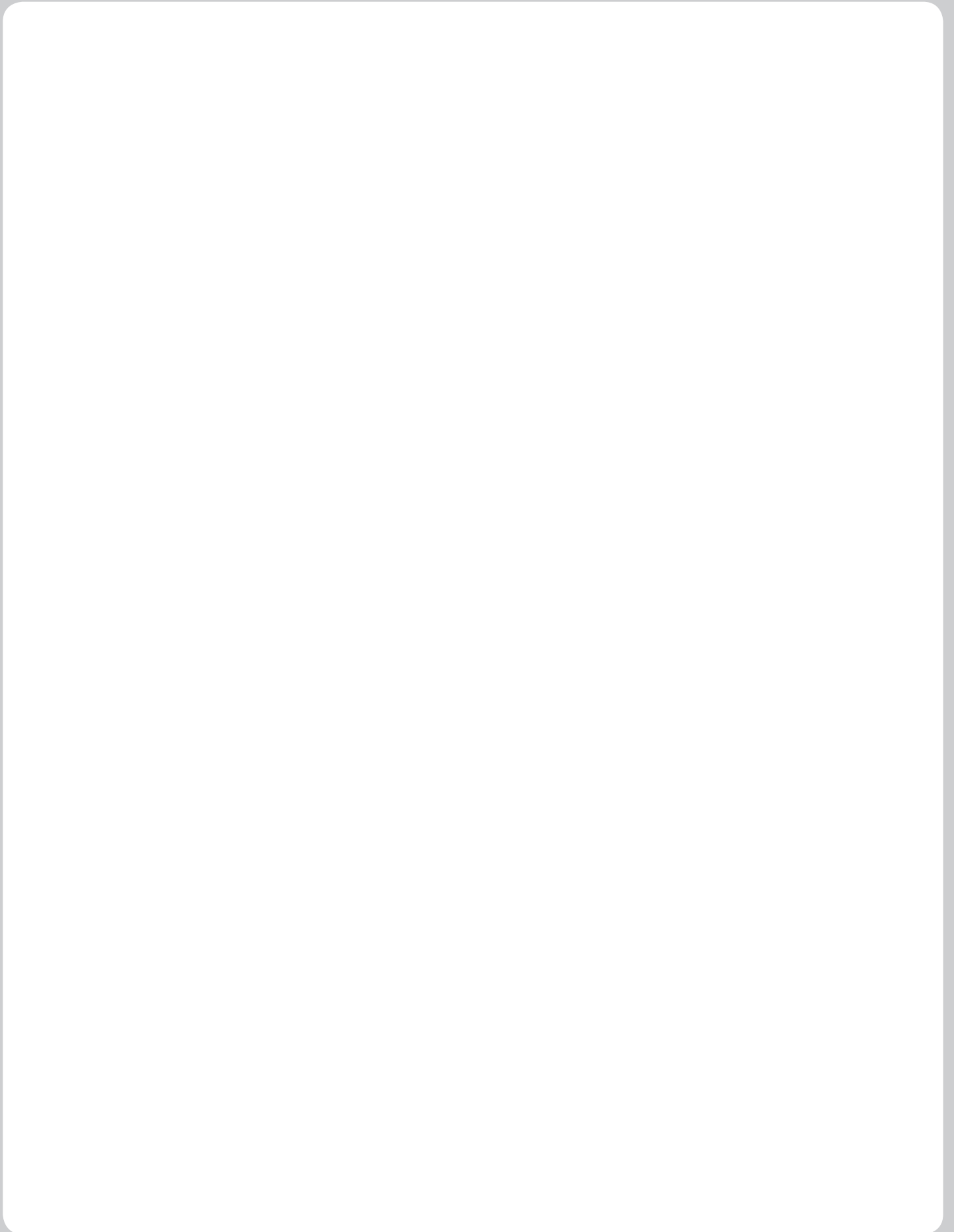

Quick Reference

DAIKIN

22.8°C
ON 18 HR. OFF 18 HR.

AUTO **OFF**
COOL **DRY**
HEAT **FAN ONLY**

TEMP **FAN**

SWING

| | |
|--|-----------------|
| | 10.0°C ↔ 30.0°C |
| | 18.0°C ↔ 32.0°C |
| | 18.0°C ↔ 30.0°C |

DAIKIN INDUSTRIES, LTD.

Head office:
Umeda Center Bldg., 2-4-12, Nakazaki-Nishi,
Kita-ku, Osaka, 530-8323 Japan

Tokyo office:
JR Shinagawa East Bldg., 2-18-1, Konan,
Minato-ku, Tokyo, 108-0075 Japan
<https://www.daikin.com>



The two-dimensional bar code is a manufacturing code.



OPERATION MANUAL

DAIKIN ROOM AIR CONDITIONER

MODELS

- DTXF60T2VMA
- DTXF71T2VMA

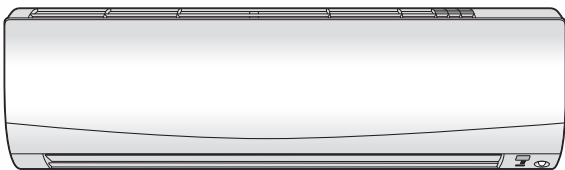

Feature

For your comfort and energy saving



INTELLIGENT EYE

The INTELLIGENT EYE sensor detects the human movement in a room. If no one is in the room more than 20 minutes, the operation automatically changes to energy saving operation.

▶Page 14

Other functions



COMFORT AIRFLOW

The airflow direction is upward while in COOL operation, and downward while in HEAT operation. This function prevents cold or warm air from blowing directly on your body.

▶Page 13



OUTDOOR UNIT QUIET











OUTDOOR UNIT QUIET operation lowers the noise level of the outdoor unit. This function is useful when you need to consider the noise for your neighbourhood. ▶Page 19

Contents

■ Read before Operation

| | |
|------------------------------------|---|
| Safety Precautions | 3 |
| Name of Parts | 5 |
| Preparation before Operation | 8 |

■ Operation

| | |
|---|----|
|  AUTO · DRY · COOL · HEAT. FAN ONLY Operation | 9 |
|  Adjusting the Airflow Direction | 11 |
|  Adjusting the Airflow Rate | 12 |
|  COMFORT AIRFLOW Operation..... | 13 |
|  INTELLIGENT EYE Operation..... | 14 |
|  POWERFUL Operation | 16 |
|  ECONO Operation..... | 17 |
|  OUTDOOR UNIT QUIET Operation..... | 19 |
|  OFF TIMER Operation | 20 |
|  ON TIMER Operation..... | 21 |

■ Care

| | |
|-------------------------|----|
| Care and Cleaning | 22 |
|-------------------------|----|

■ Troubleshooting

| | |
|-----------------------|----|
| Troubleshooting | 27 |
|-----------------------|----|



ECONO

This function enables efficient operation by limiting the maximum power consumption. It is useful when using the air conditioner and other electrical devices simultaneously. ▶Page 17

Safety Precautions



Read the precautions in this manual carefully before operating the unit.



This appliance is filled with R32.





- Keep this manual where the user can easily find it.
- The precautions described herein are classified as WARNING and CAUTION. They both contain important information regarding safety. Be sure to observe all precautions without fail.

WARNING

Failure to follow these instructions properly may result in personal injury or loss of life.

CAUTION

Failure to follow these instructions properly may result in property damage or personal injury, which may be serious depending on the circumstances.

| | | |
|---|---|---|
|  Never attempt. |  Be sure to follow the instructions. |  Be sure to establish an earth connection. |
|  Never touch the air conditioner nor the remote controller with wet hands. |  Never wet the air conditioner nor the remote controller | |

- After reading, keep this manual in a convenient place so that you can refer to it whenever necessary. If the equipment is transferred to a new user, be sure also to hand over the manual.

WARNING



- Do not use means to accelerate the defrosting process or to clean, other than those recommended by the manufacturer.
- The appliance must be stored in a room without continuously operating ignition sources (for example: open flames, an operating gas appliance or an operating electric heater).
- Do not pierce or burn.
- Be aware that refrigerants may not contain an odour.
- The appliance must be installed, operated and stored in a room with floor area larger than $-*m^2$ for 60 class, $4.6m^2$ for 71 class.
* Since the maximum refrigerant charge of the models is below 1.84kg, it does not have any limitation for the minimum floor area.
- To avoid fire, explosion or injury, do not operate the unit when harmful gases (e.g. flammable or corrosive) are detected near the unit.
- Be aware that prolonged, direct exposure to cool or warm air from the air conditioner, or to air that is too cool or too warm, can be harmful to your physical condition and health.
- Do not place objects, including rods, your fingers, etc., in the air inlet or outlet. Product damage or personal injury may result due to contact with the air conditioner's high-speed fan blades.
- Do not attempt to repair, dismantle, reinstall or modify the air conditioner yourself as this may result in water leakage, electric shocks or fire hazards.
- Do not use flammable spray near the air conditioner, or otherwise fire may result.
- When the air conditioner is malfunctioning (giving off a burning odour, etc.) turn off power to the unit and contact your local dealer. Continued operation under such circumstances may result in a failure, electric shocks or fire hazards.
- Do not use a refrigerant other than the one indicated on the outdoor unit (R32) when installing, moving or repairing. Using other refrigerants may cause trouble or damage to the unit, and personal injury.



- To avoid electric shocks, do not operate with wet hands.



- Beware of fire in case of refrigerant leakage. If the air conditioner is not operating correctly, i.e. not generating cool or warm air, refrigerant leakage could be the cause. Consult your dealer for assistance. The refrigerant within the air conditioner is safe and normally does not leak. However, in the event of a leakage, contact with a naked burner, heater or cooker may result in generation of noxious gas. Do not use the air conditioner until a qualified service person confirms that the leakage has been repaired.
- Do not attempt to install or repair the air conditioner yourself. Improper workmanship may result in water leakage, electric shocks or fire hazards. Please contact your local dealer or qualified personnel for installation and maintenance work.
- If the air conditioner is malfunctioning (giving off a burning odour, etc.), turn off power to the unit and contact your local dealer. Continued operation under such circumstances may result in a failure, electric shocks or fire hazards.
- Be sure to install an earth leakage circuit breaker. Failure to install an earth leakage circuit breaker may result in electric shocks or fire.



- Be sure to earth the unit. Do not earth the unit to a utility pipe, lightning conductor or telephone earth lead. Imperfect earthing may result in electric shocks.

CAUTION



- Do not use the air conditioner for purposes other than those for which it is intended. Do not use the air conditioner for cooling precision instruments, food, plants, animals or works of art as this may adversely affect the performance, quality and/or longevity of the object concerned.
- Do not expose plants or animals directly to the airflow from the unit as this may cause adverse effects.
- Do not place appliances that produce naked flames in places exposed to the airflow from the unit as this may impair combustion of the burner.



CAUTION



- Do not block the air inlets nor outlets. Impaired airflow may result in insufficient performance or trouble.
 - Do not sit on the outdoor unit, put things on the unit, or pull the unit. Doing so may cause accidents, such as falling or toppling down, thus resulting in injury, product malfunctioning, or product damage.
 - Do not give impact to the indoor and outdoor units, or otherwise product damage may result.
 - Do not place objects that are susceptible to moisture directly beneath the indoor or outdoor units. Under certain conditions, condensation on the main unit or refrigerant pipes, air filter dirt or drain blockage may cause dripping, resulting in fouling or failure of the object concerned.
 - After prolonged use, check the unit stand and its mounts for damage. If they are left in a damaged condition, the unit may fall and cause injury.
 - To avoid injury, do not touch the air inlet or aluminium fins of the indoor or outdoor units.
 - The appliance is not intended for use by unattended young children or infirm persons. Impairment of bodily functions and harm to health may result.
 - Children should be supervised to ensure that they do not play with the unit or its remote controller. Accidental operation by a child may result in impairment of bodily functions and harm health.
 - Do not place flammable items, such as spray cans, within 1m of the air outlet.
The spray cans may explode as a result of hot air from the indoor or outdoor units.
 - Be careful not to let pets urinate on the air conditioner. Urination on the air conditioner may result in electric shocks or fire.
 - Do not sit or hang on the panel. The panel may fall, and injury or product malfunctioning may result.
 - Do not sway the panel. The panel may hit people or objects, and injury or property damage may result.
 - Do not let children play around the panel. Injury or property damage may result.
 - Do not pull the wires. The wires may be broken and the panel may fall, and injury or property damage may result.
 - Do not locate obstacles in the route. The panel may fall, and injury or property damage may result.
 - Do not bend or damage the wires. The wires may be broken and the panel may fall, and injury or property damage may result.
 - Do not wash the air conditioner with water, as this may result in electric shocks or fire.
 - Do not place water containers (vases, etc.) above the unit, as this may result in electric shocks or fire hazards if they should topple over.
 - Do not put objects on the panel, or otherwise production malfunctioning may result.
 - Do not use an unstable stand at the time of operating or maintaining the air conditioner, or otherwise you may topple over or injure yourself.
 - Locate the remote controller in places out of reach of children. The wrong operation of the remote controller may result in injury.
- To avoid oxygen depletion, ensure that the room is adequately ventilated if equipment such as a burner is used together with the air conditioner.
- Before cleaning, be sure to stop unit operation and turn off the circuit breaker. Otherwise, an electric shock and injury may result.
 - Only connect the air conditioner to the specified power supply circuit. Power supplies other than the one specified may result in electric shocks, overheating and fires.
 - Arrange the drain hose to ensure smooth drainage. Imperfect drainage may cause wetting of the building, furniture, etc.
 - Do not place objects in direct proximity of the outdoor unit and do not let leaves and other debris accumulate around the unit. Leaves are a hotbed for small animals which can enter the unit. Once inside the unit, such animals can cause malfunctions, smoke or fire if they come into contact with electrical parts.
 - Do not place objects around the indoor unit.
Doing so may have an adverse influence on the performance, product quality, and life of the air conditioner.



Installation site

- To install the air conditioner in the following types of environments, consult your dealer.
 - Places with an oily environment or where steam or soot occurs.
 - Salty environments such as coastal areas.
 - Places where sulphide gas occurs such as hot springs.
 - Places where snow may block the outdoor unit.
- Be sure to follow the instructions below.
 - The indoor unit is at least 1m away from any television or radio set (unit may cause interference with the picture or sound).
 - The drain from the outdoor unit must be discharged to a place of good drainage.

Consider nuisance to your neighbours from noises

- For installation, choose a place as described below.
 - A place solid enough to bear the weight of the unit and which does not amplify the operation noise or vibration.
 - A place from where the air discharged from the outdoor unit or the operation noise will not annoy your neighbours.

Electrical work

- For the power supply, be sure to use a separate power circuit dedicated to the air conditioner.

System relocation

- Relocating the air conditioner requires specialized knowledge and skills. Please consult your dealer if relocation is necessary for moving or remodelling.

Name of Parts

Indoor Unit

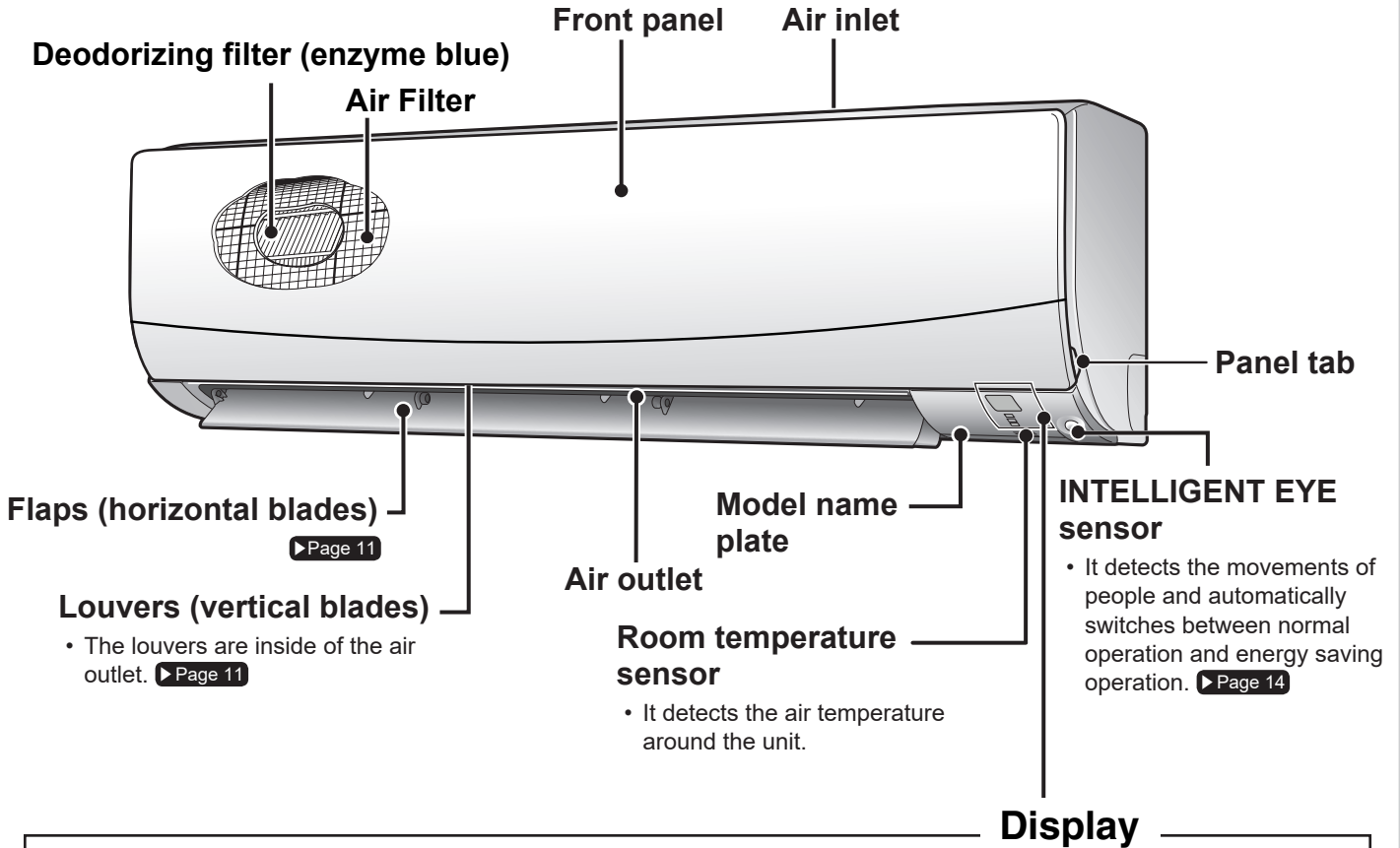

Signal receiver

- It receives signals from the remote controller.
- When the unit receives a signal, you will hear a short beep.
 - Operation start beep-beep
 - Settings changed beep
 - Operation stop beeeep

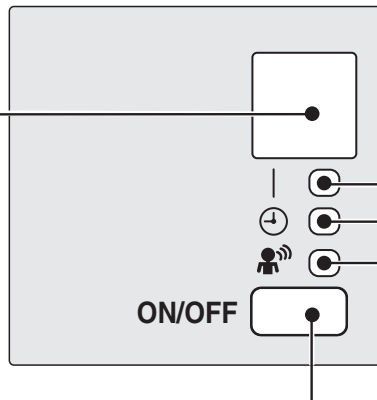

Operation lamp (green)

TIMER lamp (orange) :

▶Page 20,21

INTELLIGENT EYE lamp (green) :

▶Page 15

Indoor Unit ON/OFF switch

- Push this switch once to start operation. Push once again to stop it.
- The operation mode refer to the following table.

| Mode | Temperature setting | Airflow rate |
|------|---------------------|--------------|
| AUTO | 25.0°C | AUTO |

- This switch can be used when the remote controller is missing.

■ Open the front panel

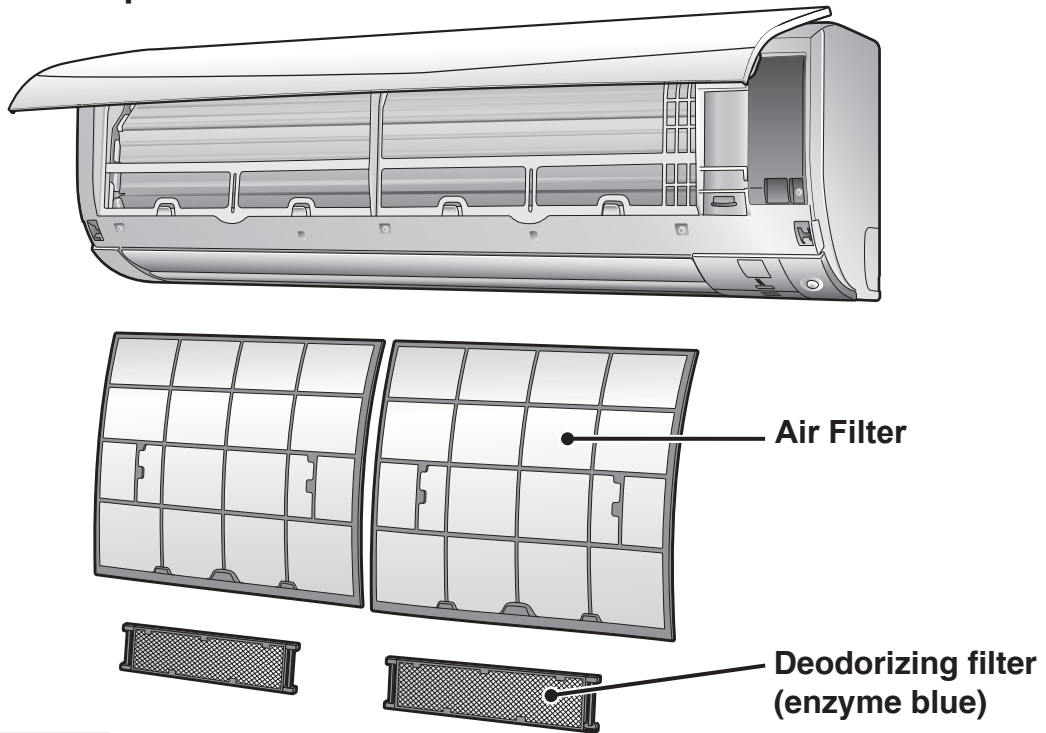

Outdoor Unit

For 60 class

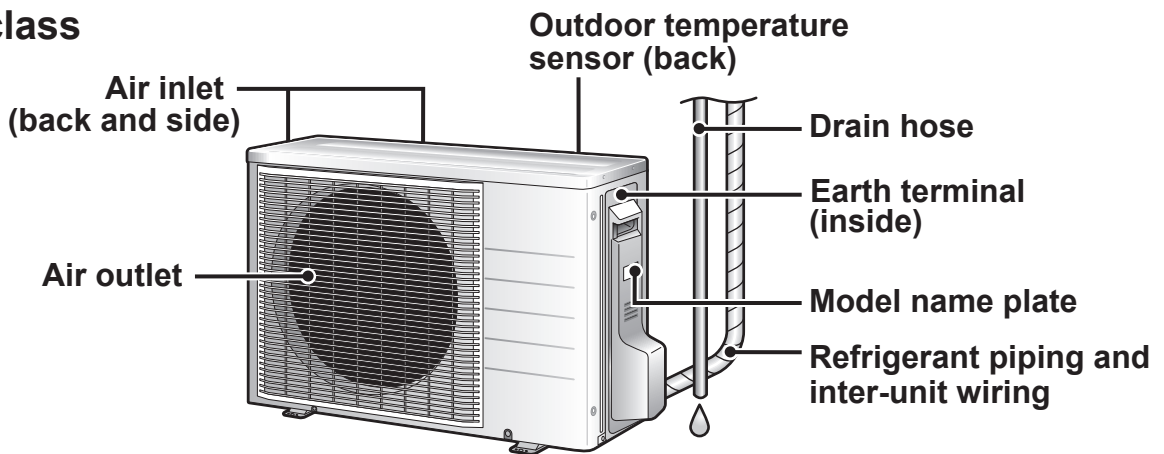

For 71 class

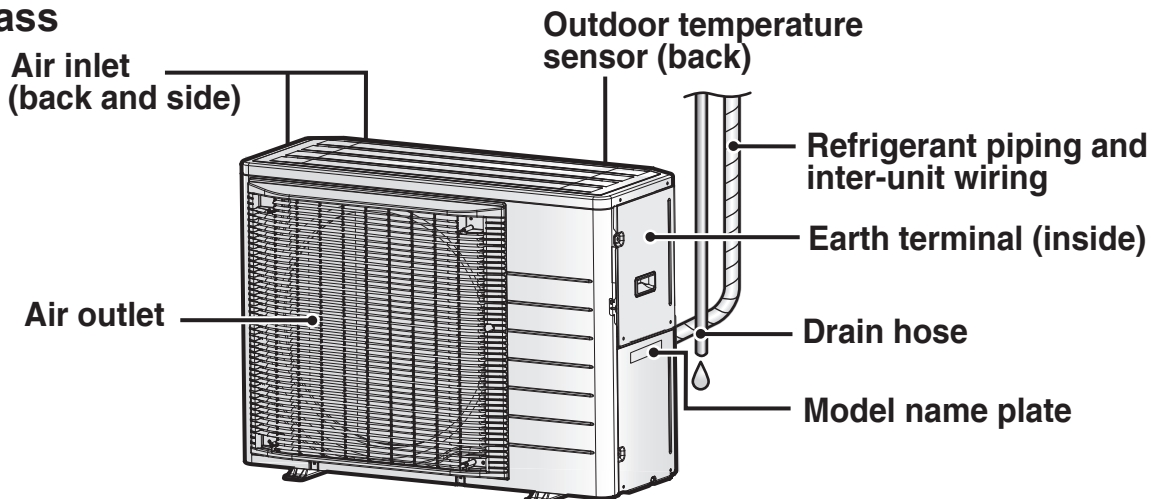

Name of Parts

Remote Controller

Signal transmitter

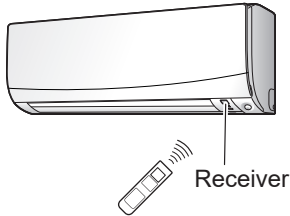

- To use the remote controller, aim the transmitter at the indoor unit. If there is anything to block signals between the unit and the remote controller, such as a curtain, the unit will not receive signals.
- Do not drop the remote controller.
- Do not get it wet.
- The maximum distance for communication is approx. 7m.

Direct operation buttons

- It start operation of the selected mode. (AUTO/DRY/COOL/HEAT/FAN ONLY)

TEMPERATURE adjustment buttons

- It changes the temperature setting.

SENSOR button

- INTELLIGENT EYE operation.

QUIET button

- OUTDOOR UNIT QUITE operation.

OFF TIMER button (Night set mode)

ON TIMER button

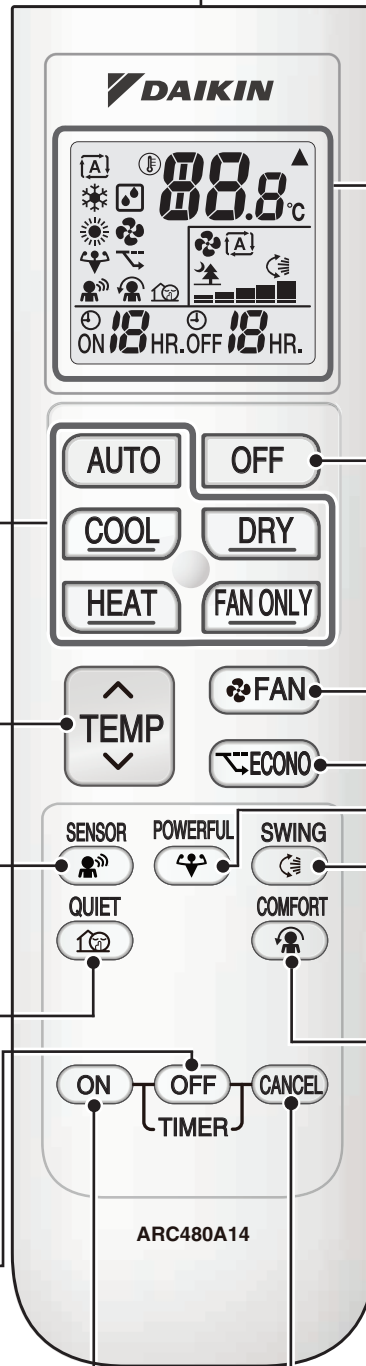

Display (LCD)

- It displays the current settings. (In this illustration, each section is shown with its displays on for the purpose of explanation.)

OFF button

- Press this button to stop operation.

FAN setting button

- It selects the airflow rate setting.

ECONO button

- ECONO operation.

POWERFUL button

- POWERFUL operation.

SWING button

- Adjusting airflow direction.

COMFORT AIRFLOW button

- COMFORT AIRFLOW operation.

TIMER CANCEL button

- It cancels the timer setting.

Model ARC480A14

Preparation before Operation

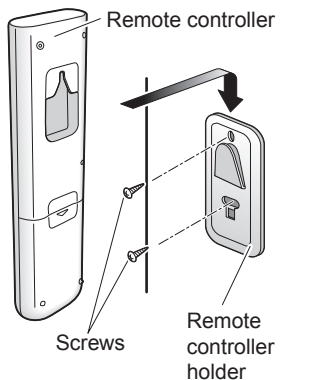
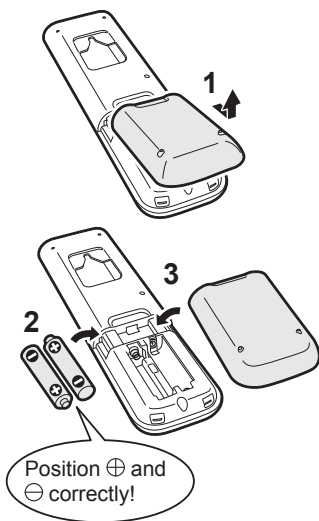

■ To set the batteries

1. Slide the back cover to take it off.
2. Set two dry batteries AAA.LR03 (alkaline).
3. Set the back cover as before.

■ To fix the remote controller holder on the wall

1. Choose a place from where the signals can reach the unit.
2. Fix the holder to a wall, a pillar, or similar location with the screws supplied with the accessory set.
3. Place the remote controller in the remote controller holder.

■ Turn the breaker on

- After the power is turned on, the flaps of the indoor unit opens and closes once to set the reference position.

NOTE

■ Notes on batteries

- When replacing the batteries, use batteries of the same type, and replace both old batteries together.
- When the system is not used for a long time, take the batteries off.
- The batteries will last for approx. 1 year. If the remote controller display begins to fade and the degradation of reception performance occurs within a year, however, replace both batteries with new, size AAA.LR03 (alkaline).
- The attached batteries are provided for the initial use of the system.
The usable period of the batteries may be short depending on the manufactured date of the air conditioner.

■ Low batteries alert

- To prevent remote controller from deteriorate batteries. When batteries seem to be dying (battery voltage lower).
The LCD will blink and the remote controller will stop all operations except to turn off the air conditioner.
To operate remote controller again, replace all the batteries with the new, size AAA. LR03 (Alkaline).

■ Notes on remote controller

- Never expose the remote controller to direct sunlight.
- Dust on the signal transmitter or receiver will reduce the sensitivity. Wipe off dust with soft cloth.
- Signal communication may be disabled if an electronic-starter-type fluorescent lamp (such as inverter-type lamps) is in the room. Consult the shop if that is the case.
- If the remote controller signals happen to operate another appliance, move that appliance to somewhere else, or consult the service shop.



AUTO · DRY · COOL · HEAT · FAN ONLY Operation

The air conditioner operates in the user selected operation mode.



■ To start operation

Press button of your desired operation mode.

AUTO operation

Press **AUTO** button. “**A**” appears on the LCD.

COOL operation

Press **COOL** button. “**❄**” appears on the LCD.

DRY operation

Press **DRY** button. “**☁**” appears on the LCD.

HEAT operation

Press **HEAT** button. “**☀**” appears on the LCD.

FAN ONLY operation

Press **FAN ONLY** button. “**🌀**” appears on the LCD.

- The OPERATION lamp lights green.

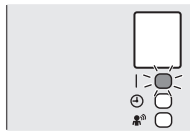

Display

- Operation mode can be change while operating by press your desired operation mode button.

■ To stop operation

Press **OFF**

- The OPERATION lamp goes off.

NOTE

| MODE | Notes on each operation mode |
|----------|---|
| HEAT | <ul style="list-style-type: none"> • Since this air conditioner heats the room by taking heat from outdoor air to indoors, the heating capacity becomes smaller in lower outdoor temperatures. If the heating effect is insufficient, it is recommended to use another heating appliance in combination with the air conditioner. • The heat pump system heats the room by circulating hot air around all parts of the room. After the start of HEAT operation, it takes some time before the room gets warmer. |
| COOL | <ul style="list-style-type: none"> • This air conditioner cools the room by releasing the heat in the room outside. Therefore, the cooling performance of the air conditioner may be decrease if the outdoor temperature is high. |
| DRY | <ul style="list-style-type: none"> • The computer chip works to rid the room of humidity while maintaining the temperature as much as possible. It automatically controls temperature and airflow rate, so manual adjustment of these functions is unavailable. |
| AUTO | <ul style="list-style-type: none"> • In AUTO operation, the system selects an appropriate operation mode (COOL or HEAT) based on the room and outside temperatures and starts the operation. • The system automatically reselects setting at a regular interval to bring the room temperature to user-setting level. |
| FAN ONLY | <ul style="list-style-type: none"> • This mode is valid for fan only. |

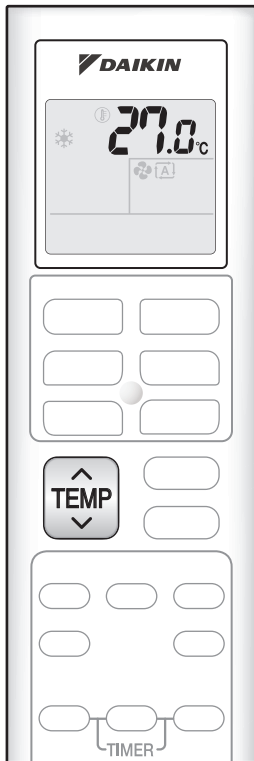

■ To change the temperature setting

Press  .

- The displayed items on the LCD will change whenever either one of the buttons is pressed.

| COOL operation | HEAT operation | AUTO operation | DRY or FAN ONLY operation |
|---|----------------|----------------|---|
| 18.0-32.0°C | 10.0-30.0°C | 18.0-30.0°C | The temperature setting is not available. |
| Press ▲ to raise the temperature and press ▼ to lower the temperature 0.5°C each press. | | | |

■ Operating conditions

■ Recommended temperature setting

- For cooling: 26.0-28.0°C
- For heating: 20.0-24.0°C

■ Tips for saving energy

- Be careful not to cool (heat) the room too much.
Keeping the temperature setting at a moderate level helps save energy.
- Cover windows with a blind or a curtain.
Blocking sunlight and air from outdoors increases the cooling (heating) effect.
- Clogged air filters cause inefficient operation and waste energy. Clean them once in about every 2 weeks.

■ Notes on the operating conditions

- The air conditioner always consumes a small amount of electricity even while it is not operating.
- If you are not going to use the air conditioner for a long period, for example in spring or autumn, turn the breaker off.
- Use the air conditioner in the following conditions.

| MODE | Operating conditions | If operation is continued out of this range |
|------|--|--|
| COOL | Outdoor temperature : -10.0 ~ 46.0°C Indoor temperature : 18.0-32.0°C Indoor humidity : 80% max. | <ul style="list-style-type: none"> • A safety device may work to stop the operation. • Condensation may occur on the indoor unit and drip. |
| HEAT | Outdoor temperature : -15.0 ~ 24.0°C Indoor temperature : 10.0-30.0°C | <ul style="list-style-type: none"> • A safety device may work to stop the operation. |
| DRY | Outdoor temperature : -10.0 ~ 46.0°C Indoor temperature : 18.0-32.0°C Indoor humidity : 80% max. | <ul style="list-style-type: none"> • A safety device may work to stop the operation. • Condensation may occur on the indoor unit and drip. |

- Operation outside this humidity or temperature range may cause a safety device to disable the system.



Adjusting the Airflow Direction

ATTENTION

- Always use a remote controller to adjust the angles of the flaps. If you attempt to move the flaps forcibly by hand when they are swinging, the mechanism may be broken.



You can adjust the airflow direction to increase your comfort.

■ To start auto swing

Upper and lower airflow direction

Press .

- “” appears on the LCD.
- The flaps (horizontal blades) will begin to swing.

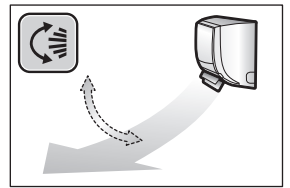

■ To set the flaps at desired position

- This function is effective while flaps are in auto swing mode.

Press  when the flaps the desired position.

- “” disappears from the LCD.

■ To adjust the louvers (vertical blades)

Hold the knob and move the louvers.

(You will find a knob on the left-side and the right-side blades.)

- When the unit is installed in the corner of a room, the direction of the louvers should be facing away from the wall.

If they face the wall, the wall will block off the wind, causing the cooling (or heating) efficiency to drop.

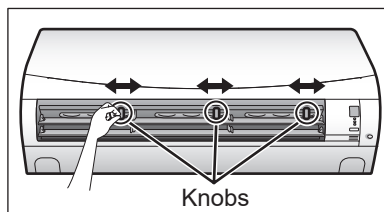

- There is a knob in 3 places.

NOTE

■ Notes on airflow direction setting

- The movable range of the flaps varies according to the operation mode.
- The flap will stop at the upper position when the airflow rate is changed to low during the up and down swing setting.

■ Note on airflow rate setting

- At smaller airflow rates, the cooling (heating) effect is also smaller.

Movable range of the flap

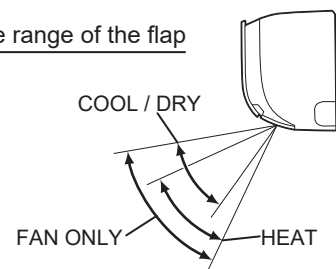



Adjusting the Airflow Rate

You can adjust the airflow rate to increase your comfort.

■ To adjust the airflow rate setting

Press FAN .

- Each pressing of change the airflow rate setting in sequence shown below.

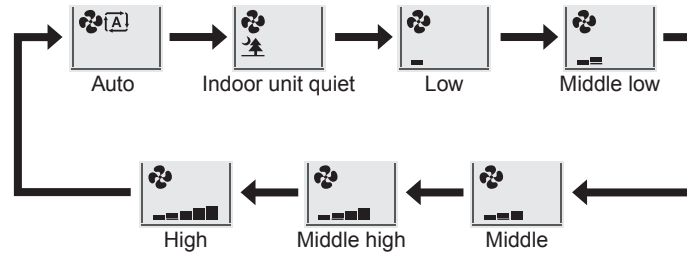

- When the airflow is set to “”, indoor unit quiet operation will start and the noise from the unit will become quieter.
- In indoor unit quiet operation, the airflow rate is set to a weak level.
- If the temperature dose not reach the desired point, change the airflow rate setting.
- In DRY mode, the airflow rate setting is not available.





COMFORT AIRFLOW Operation



The air direction and flow rate are adjusted so that the air will not blow directly at people in the room.

■ To start COMFORT AIRFLOW operation

Press .

- “” is displayed on the LCD.

| | COOL and DRY operation | HEAT operation | FAN ONLY operation |
|----------------|------------------------|----------------|--------------------|
| Flap direction | Goes up | Goes down | Not available |
| Airflow rate | AUTO | | |

■ To cancel COMFORT AIRFLOW operation

Press  again.

- “” disappears from the LCD.
- The flap will return to the memory position from before COMFORT AIRFLOW operation.

Notes on COMFORT AIRFLOW operation

- The flap position will change, preventing air from blowing directly on the occupants of the room.
- POWERFUL operation and COMFORT AIRFLOW operation cannot be used at the same time. Priority is given to the function of whichever button is pressed last.
- The airflow rate will be set to AUTO. If the upper and lower airflow direction is selected, the COMFORT AIRFLOW operation will be canceled.
- The flow of air will be in the upward direction while in COOL operation and in the downward direction while in HEAT operation, which will provide a comfortable wind that will not come in direct contact with people.

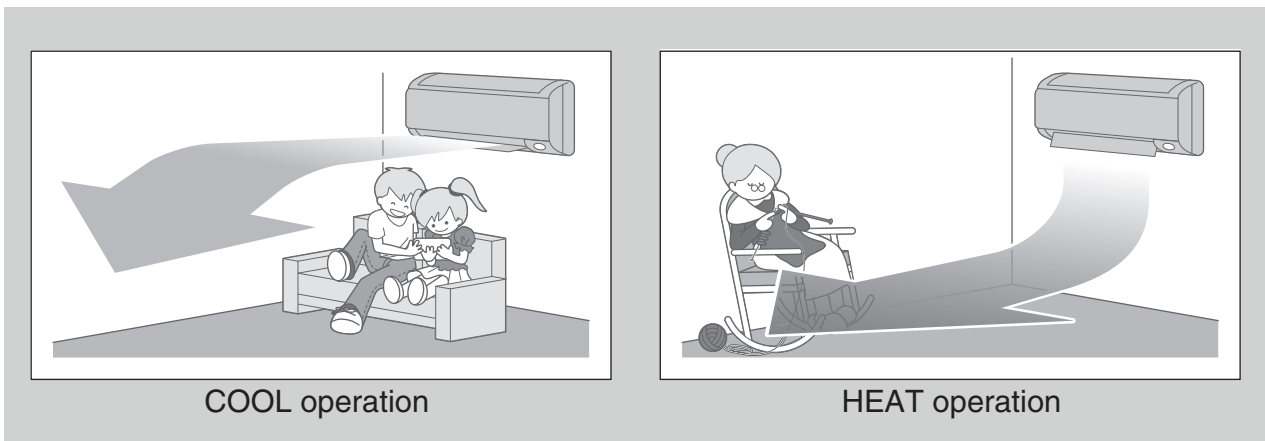



INTELLIGENT EYE Operation

■ INTELLIGENT EYE operation

“INTELLIGENT EYE” is the infrared sensor which detects the human movement.

If no one is in the room for more than 20 minutes, the operation automatically changes to energy saving operation.

The INTELLIGENT EYE sensor according to the following situations.

[Example]

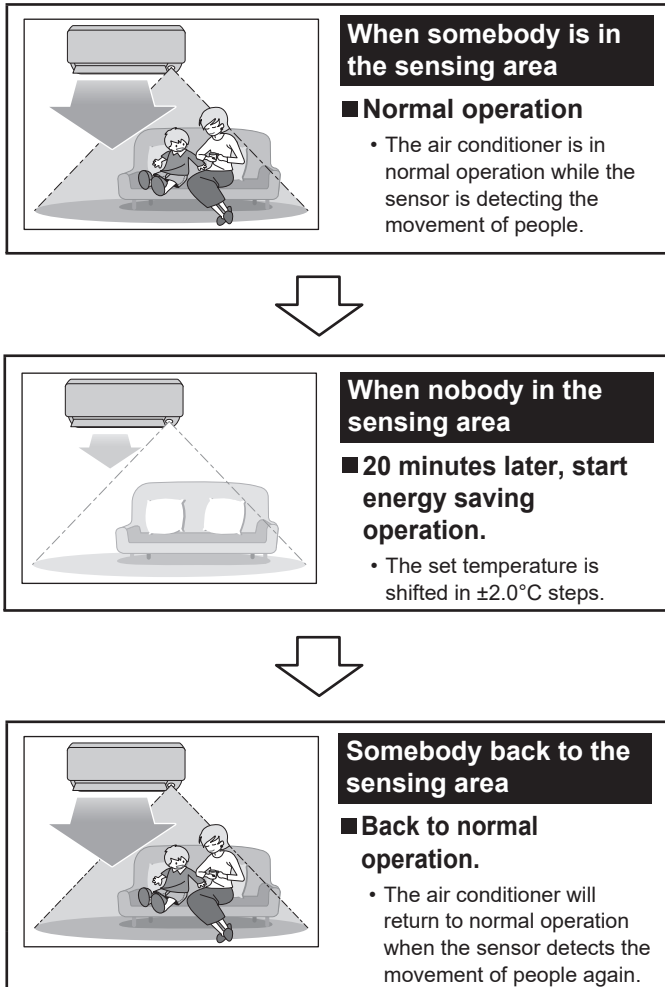

INTELLIGENT EYE operation is useful for energy saving

■ Energy saving operation

- If no presence detected in the room for 20 minutes, the energy saving operation will start.
- This operation changes the temperature -2.0°C in HEAT / $+2.0^{\circ}\text{C}$ in COOL / $+2.0^{\circ}\text{C}$ in DRY operation from set temperature. When the room temperature exceeds 30.0°C , the operation changes the temperature $+1.0^{\circ}\text{C}$ in COOL / $+1.0^{\circ}\text{C}$ in DRY operation from set temperature.
- This operation decreases the airflow rate slightly in FAN operation only.



INTELLIGENT EYE Operation

CAUTION

- Do not place large objects near the INTELLIGENT EYE sensor. Also keep heating units or humidifiers outside the sensor's detection area. This sensor can detect undesirable objects.
- Do not hit or violently push the INTELLIGENT EYE sensor. This can lead to damage and malfunction.



To start intelligent eye operation

Press .

- “” appears on the LCD.
- The INTELLIGENT EYE lamp lights green.

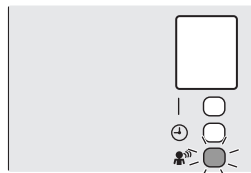

Display

- By selecting “” the air conditioner will be in INTELLIGENT EYE operation.
- The lamp will be lit while human movements are detected.

To cancel operation

Press  again.

- The INTELLIGENT EYE lamp goes off.
- “” disappears from the LCD.

NOTE

Notes on INTELLIGENT EYE operation

- Application range is as follows.

Vertical angle 90°
(Side view)

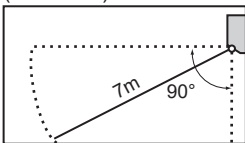

Horizontal angle 110°
(Top view)

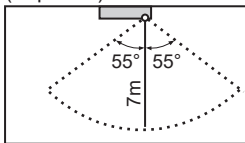

- While the air conditioner is in INTELLIGENT EYE operation, if no people are detected in sensing area within 20 minutes, the air conditioner will go into energy-saving mode with the set temperature shifted by 2.0°C. The air conditioner may go into energy-saving operation even if there are people in the area. This may occur depending on the clothes the people are wearing if there are no movements of the people in the area.
- Due to the position of the sensor, people might be exposed to the airflow of the indoor unit if they are close to the front side of the indoor unit.
- Sensor may not detect moving objects further than 7m away. (Check the application range.)
- Sensor detection sensitivity changes according to indoor unit location, the speed of passersby, temperature range, etc.
- The sensor also mistakenly detects pets, sunlight, fluttering curtains and light reflected off of mirrors as passersby.
- INTELLIGENT EYE operation will not go on during POWERFUL operation.
- NIGHT SET mode  Page 20 will not go on during use of INTELLIGENT EYE operation.



POWERFUL Operation

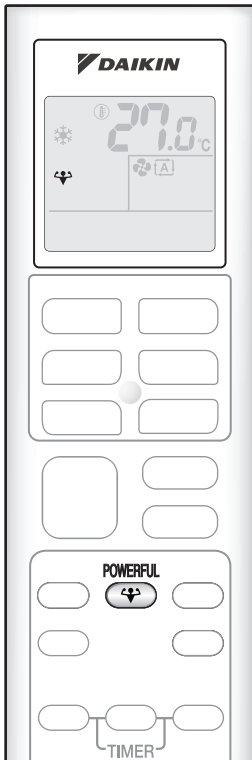

POWERFUL operation quickly maximizes the cooling (heating) effect in any operation modes. You can get the maximum capacity.

■ To start POWERFUL operation

Press  during operation.

- POWERFUL operation ends in 20 minutes. Then the system automatically operates again with the previous settings which were used before POWERFUL operation.
- “” appears on the LCD.

■ To cancel POWERFUL operation

Press  again.

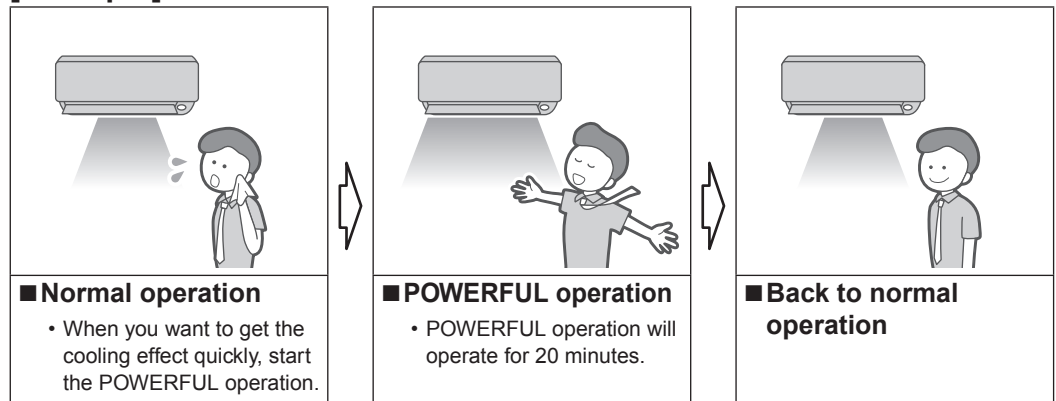

- “” disappears from the LCD.

[Example]



NOTE

■ Notes on POWERFUL operation

- When using POWERFUL operation, there are some functions which are not available.
- POWERFUL operation cannot be used together with ECONO or OUTDOOR UNIT QUIET operation. Priority is given to the function of whichever button is pressed last.
- POWERFUL operation can only be set when the unit is running. Pressing  causes the settings to be canceled, and “” disappears from the LCD.
- POWERFUL operation will not increase the capacity of the air conditioner if the air conditioner is already in operation with its maximum capacity demonstrated.
- **In COOL and HEAT operation**
To maximize the cooling (heating) effect, the capacity of outdoor unit is increased and the airflow rate is fixed to the maximum setting. The temperature and airflow settings are not available.
- **In DRY operation**
The temperature setting is lowered by 2.5°C and the airflow rate is slightly increased.
- **In FAN ONLY operation**
The airflow rate is fixed at the maximum speed.
- **In AUTO operation**
To maximize the cooling (heating) effect, the capacity of outdoor unit is increased and the airflow rate is fixed to the maximum setting. The temperature and airflow settings are not available.



ECONO Operation

■ ECONO operation

ECONO operation is a function which enables efficient operation by limiting the maximum power consumption value.

This function is useful for cases in which attention should be paid to ensure a circuit breaker will not trip when the product runs alongside other appliances.

[Example]

Normal operation



- In case the air conditioner and other appliances which require high power consumption are used at same time, a circuit breaker may trip if the air conditioner operate with its maximum capacity.

ECONO operation

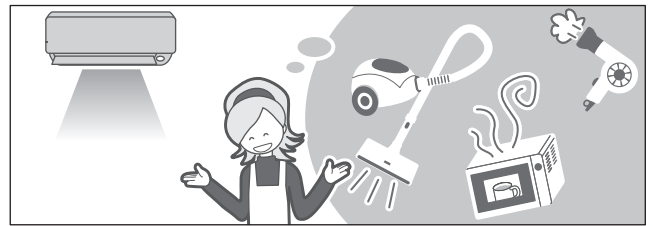

- The maximum power consumption of the air conditioner is limited by using ECONO operation. The circuit breaker will hardly trip even if the air conditioner and other appliances are used at same time.

Running current and power consumption

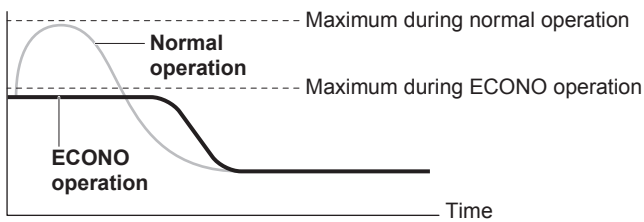

From start up until set temperature is reached

- This diagram is a representation for illustrative purposes only. The maximum running current and power consumption of the air conditioner in ECONO operation vary with the connecting outdoor unit.

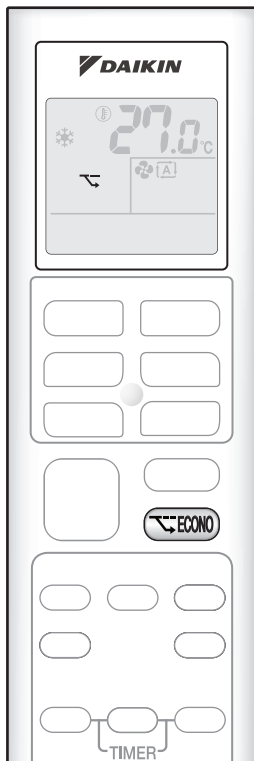

■ To start ECONO operation

Press .

- “” appears on the LCD.



■ To cancel ECONO operation

Press  again.

- “” disappears from the LCD.

NOTE

■ Notes on ECONO operation

- ECONO operation can only be set when the unit is running. Pressing  causes the settings to be canceled, and “” disappears from the LCD.
- ECONO operation is a function which enables efficient operation by limiting the power consumption of the outdoor unit (operating frequency).
- ECONO operation functions in AUTO, COOL, DRY, and HEAT operation.
- POWERFUL and ECONO operation cannot be used at the same time. Priority is given to the function of whichever button is pressed last.
- If the level of power consumption is already low, ECONO operation will not drop the power consumption.



OUTDOOR UNIT QUIET Operation

■ OUTDOOR UNIT QUIET operation

OUTDOOR UNIT QUIET operation lowers the noise level of the outdoor unit by changing the frequency and fan speed on the outdoor unit. This function is convenient during the night.

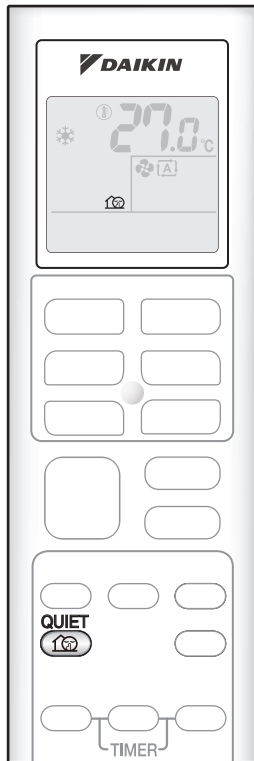

■ To start operation

Press .

- “” appears on the LCD.

■ To cancel operation

Press  again.

- “” disappears from the LCD.

[Example] Using the OUTDOOR UNIT QUIET operation during the night.

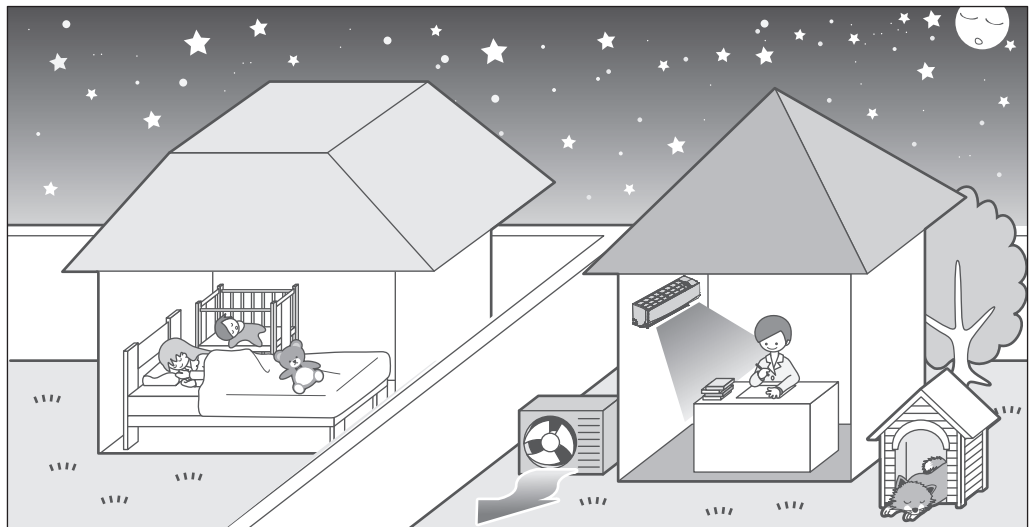

- The noise level of the outdoor unit will be lower. This function is useful when you need to consider the noise for your neighbourhood.

NOTE

■ Notes on OUTDOOR UNIT QUIET operation

- This function is available in COOL, HEAT, and AUTO operation.
This is not available in FAN ONLY and DRY operation.
- POWERFUL operation and OUTDOOR UNIT QUIET operation cannot be used at the same time.
Priority is given to the function of whichever button is pressed last.
- Even the operation is stopped by using the remote controller or the indoor unit ON/OFF switch
when using OUTDOOR UNIT QUIET operation, “” will remain on the remote controller display.
- OUTDOOR UNIT QUIET operation will drop neither the frequency nor fan speed if they have been already dropped low enough.

OFF

OFF TIMER Operation

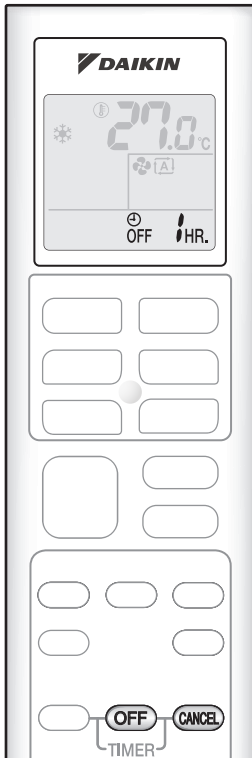

Timer functions are useful for automatically switching the air conditioner on or off at night or in the morning. You can also use OFF TIMER and ON TIMER in combination.

■ To use OFF TIMER operation

1. Press **OFF** .

• “**OFF** **1 HR.**” is display on the LCD.

2. Press **OFF** until the time setting reaches the point

- Each pressing of button increases the time setting by 1 hour.
- Setting time can be increase to 12 hours maximum.
- The TIMER lamp lights orange.

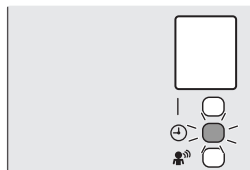

Display

■ To cancel OFF TIMER operation

Press **CANCEL** .

- “**OFF** **1 HR.**” disappear from the LCD.
- The TIMER lamp goes off.

NOTE

■ Notes on TIMER operation

- When operating the unit via the ON/OFF TIMER, the actual length of operation may vary from the time entered by the user. (Maximum approx. 10 minutes)

■ NIGHT SET mode

- When the OFF TIMER is set, the air conditioner automatically adjusts the temperature setting (0.5°C up in COOL, 2.0°C down in HEAT) to prevent excessive cooling (heating) for your pleasant sleep.

ON

ON TIMER Operation

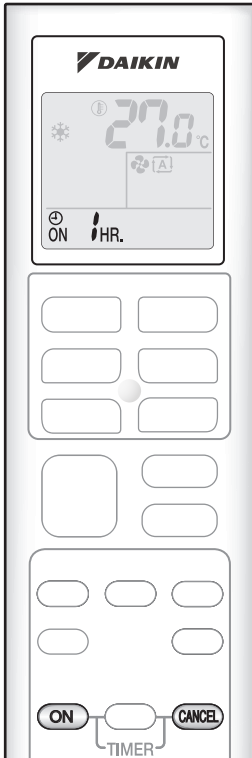

■ To use ON TIMER operation

1. Press **ON**.

• “” is display on the LCD.

2. Press **ON** until the time setting reaches the point you prefer.

- Each pressing of button increases the time setting by 1 hour.
- Setting time can be increase to 12 hours maximum.
- The TIMER lamp lights orange.

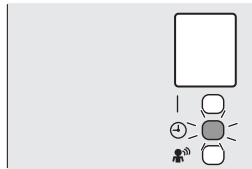

Display

■ To cancel ON TIMER operation

Press **CANCEL**.

- “” disappear from the LCD.
- The TIMER lamp goes off.

■ To combine ON TIMER and OFF TIMER

- A sample setting for combining the 2 timers is shown below.

- When setting while unit is operating.

(Example)
 Turn off unit in the next 1 hr.) Combined
 Turn on unit in the next 8 hr. (7 hr. after turn off) →

- When setting while unit is stopped.

(Example)
 Turn on unit in the next 2 hr.) Combined
 Turn off unit in the next 5 hr. (3 hr. after turn on) →

NOTE

■ In the following cases, set the timer again.

- After a breaker has turned off.
- After a power failure.
- After replacing batteries in the remote controller.

Care and Cleaning

⚠ CAUTION

- Before cleaning, be sure to stop the operation and turn the breaker off.
- Do not touch the aluminium fins of the indoor unit. If you touch those parts, this may cause an injury.

■ Quick reference

How to open / close the front panel

- Hold the front panel by the panel tabs on the both sides and open it.
- Press the front panel at both sides and the center to close it.

Cleaning parts

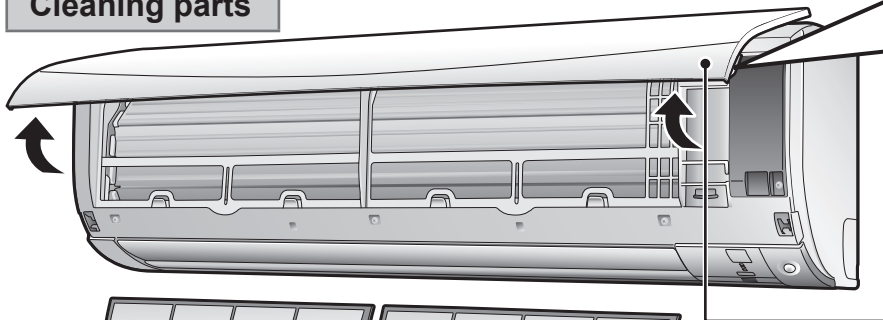

Front panel

- Wipe it with a soft damp cloth.
- Only neutral detergent may be used.

If dirty

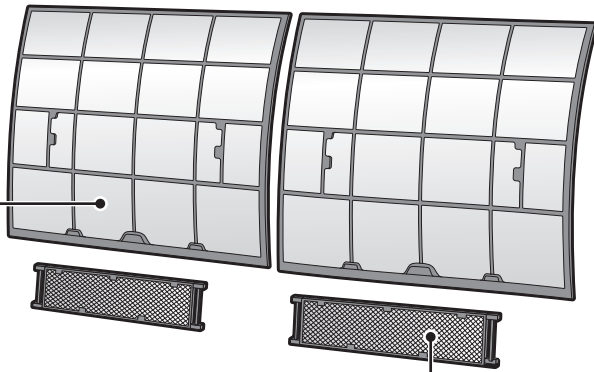

Air filter

- Vacuum dust or wash filter.

Once every 2 weeks

▶Page 24

Indoor unit and remote controller

- Wipe them with soft cloth.

If bothered by dirt

Deodorizing filter (enzyme blue)

To purchase the filters (**Table 1**) or to purchase the another type, contact the dealer where you bought the air conditioner. The method of cleaning and replacement of the filters may differ depending on the model. Refer to the label attached to the separately sold filters themselves.

Table 1

| Item | Part No. |
|---|------------|
| Air quality filter (enzyme blue with PM 2.5) - without frame (set of 2) | BAFP094A43 |
| Deodorizing filter (enzyme blue) - without frame (set of 2) | BAFP094A41 |
| Dust collection filter (PM 2.5) - without frame (set of 2) | BAFP046A41 |
| Titanium apatite deodorizing filter - without frame (set of 2) | KAF970A46 |

Deodorizing filter (enzyme blue), Titanium apatite deodorizing filter.

- Vacuum dust or replace the filter.

[Cleaning]

Once every 6 months

▶Page 25

[Replacement]

Once every 3 years

▶Page 25

Air quality filter (enzyme blue with PM 2.5), Dust collection filter (PM 2.5)

- No cleaning is required.

Please replace the filter every 6 months. ▶Page 25

NOTE

■ For cleaning, do not use the materials as follows.

- Hot water above 40.0°C.
- Benzine, gasoline, thinner, other volatile oils.
- Polishing compound.
- Scrubbing brushes, other hard stuff.



Care and Cleaning

CAUTION

- When removing or attaching the front panel, use a robust and stable stool and watch your steps carefully.
- When removing or attaching the front panel, support the panel securely with hand to prevent it from falling.
- After cleaning, make sure that the front panel is securely fixed.

■ Front panel

1. Remove the front panel.

- Open the front panel.
- Slide the front panel to either the left or right and pulling it toward you. This will disconnect the front panel shaft on one side.

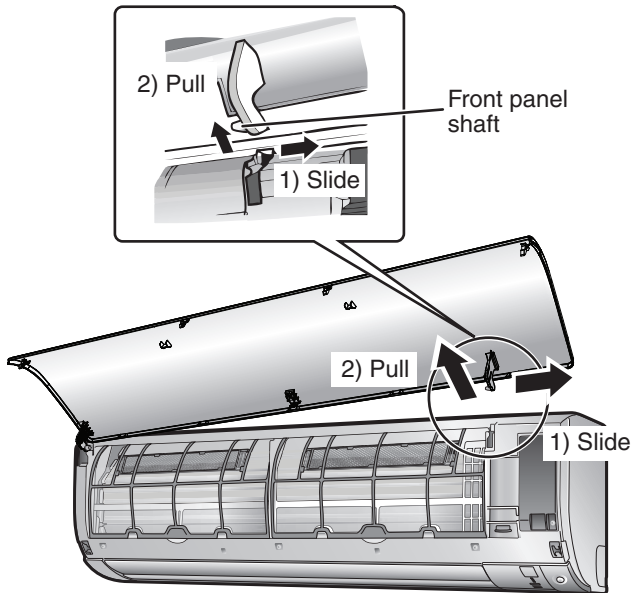

- Disconnect the front panel shaft on the other side in the same manner.

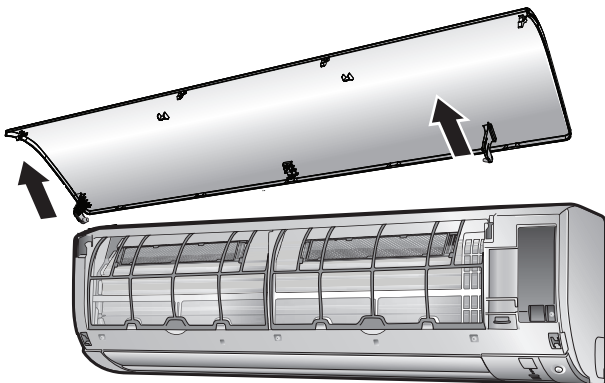

2. Clean the front panel.

- Wipe it lightly with a soft cloth soaked in water or a liquid neutral detergent.
- Wipe it with a dry soft cloth.

3. Attach the front panel.

- Align the front panel shaft on the left and right of the front panel with the slots, then push them all the way in.

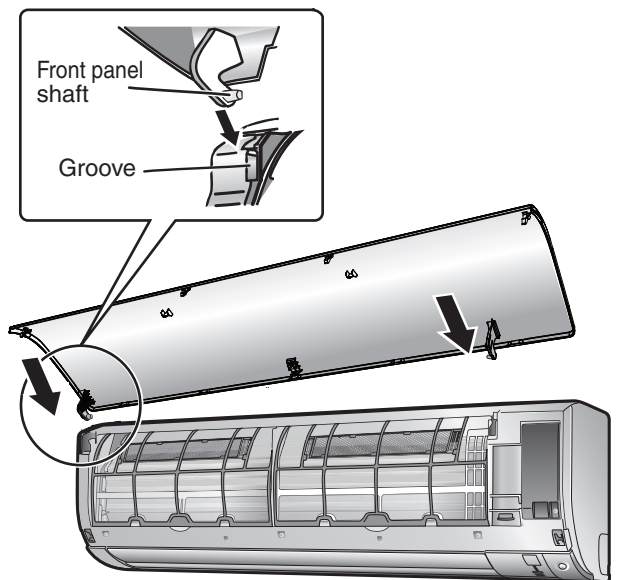

- Close the front panel slowly. (Press the panel at both sides and in the central area.)

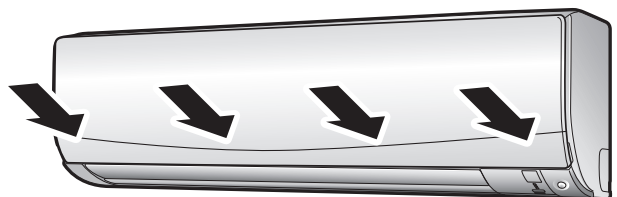

CAUTION

- Do not touch the aluminum fins by bare hand at the time of dismounting or mounting the filter.

■ Air filter

1. Pull out the air filters.

- Open the front panel.
- Push a little upwards the filter tab at the center of each air filter, then pull it down.

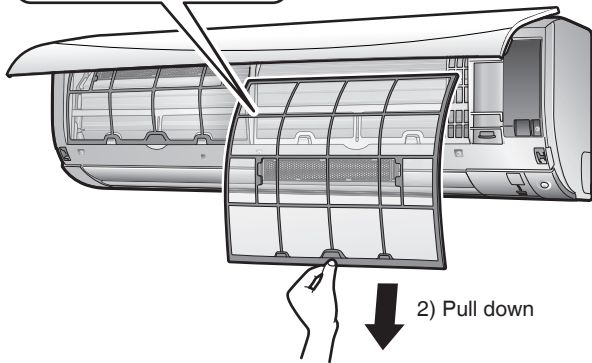
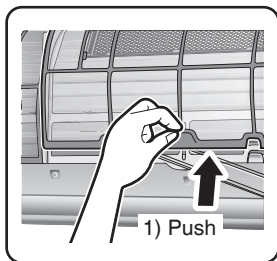

2. Wash the air filters with water or clean them with vacuum cleaner.

- It is recommended to clean the air filters every 2 weeks.

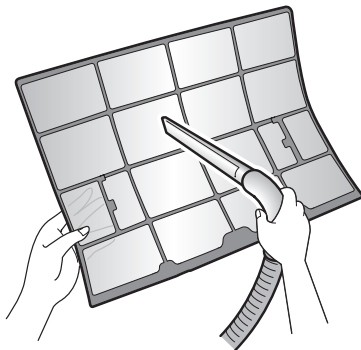

If the dust does not come off easily

- Wash the air filters with neutral detergent thinned with lukewarm water, then dry them up in the shade.
- Be sure to remove the filter (small). Refer to "Filter (small)" on the next page.

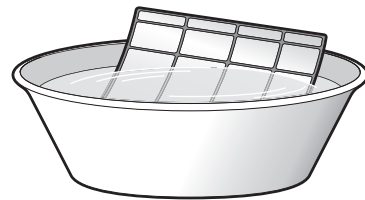

3. Set the filters as they were and close the front panel.

- Press the front panel at both sides and in the central area.

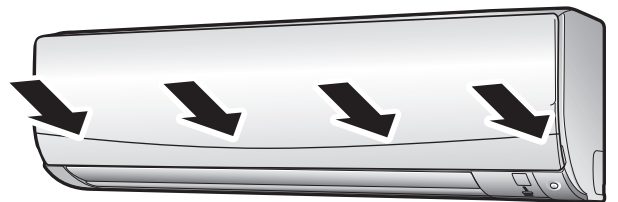

Care and Cleaning

■ Filter (small)

* For the applicable filter type, please refer to **▶Page 22**.

Attaching

1. Open the front panel and pull out the air filters. ▶Page 24

2. Insert the filter.

- Check that the filters are inserted securely under the tabs.

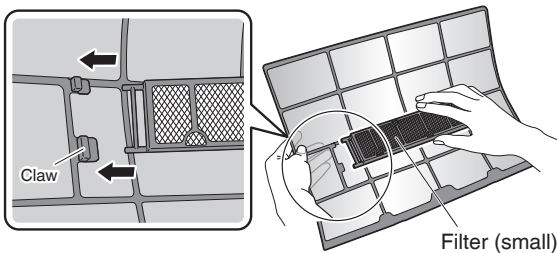

Cleaning and Replacement

1. Open the front panel and pull out the air filters. ▶Page 24

2. Take off the filter.

- Hold the recessed parts of the frame and unhook the 4 claws.
- Remove the filters from the tabs.

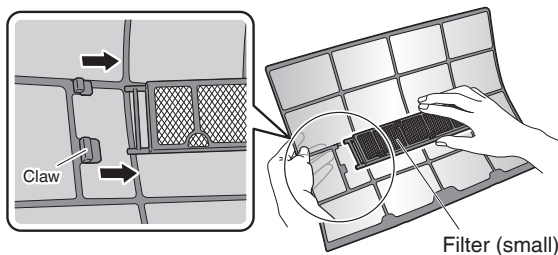

3. Clean or replace.

[Cleaning]

● **Deodorizing filter (enzyme blue) : Blue / Titanium apatite deodorizing filter : Blue-Black**

3-1 Vacuum dust, and soak in lukewarm water or water for about 10 to 15 minutes if very dirty.

3-2 After washing, shake off remaining water and let them dry in the shade.

- This filter can be renewed by washing it with water once **every 6 months** and we recommend replacing it once **every 3 years**.
- Do not wring out the filter when removing water from it.

● **Air quality filter (enzyme blue with PM 2.5) : Blue-White / Dust collection filter (PM 2.5) : White**

- Do not wash the filters as this will reduce their efficiency.
- It is recommended to replace it once **every 6 months**.

[Replacement]

Remove the filter from the filter frame and prepare a new one.

- Do not throw away the filter frame.
- Reuse the filter frame when replacing the filter.
- When attaching the filter, check that the filter is properly set in the tabs.

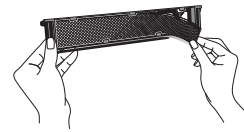

4. Set the filters as they were and close the front panel.

- Press the front panel at both sides and the center.

NOTE

- Operation with dirty filters:
 - cannot deodorise the air,
 - cannot clean the air,
 - results in poor heating or cooling,
 - may cause odour.
- Dispose of old filters as non-flammable waste.

■ Check the units

- Check that the base, stand and other fittings of the outdoor unit are not decayed or corroded.
- Check that nothing blocks the air inlets and the outlets of the indoor unit and the outdoor unit.
- Check that the drain comes smoothly out of the drain hose during COOL or DRY operation.
 - If no drain water is seen, water may be leaking from the indoor unit. Stop operation and consult the service shop if this is the case.

■ Before a long idle period

1. Operate the FAN only for several hours on a fine day to dry out the inside.

- Press **FAN ONLY** to start “ Fan only ” operation.

2. After operation stops, turn off the breaker for the room air conditioner.

3. Clean the air filters and set them again.

4. Take out batteries from the remote controller.

■ We recommend periodical maintenance

- In certain operating conditions, the inside of the air conditioner may get foul after several seasons of use, resulting in poor performance. It is recommended to have periodical maintenance by a specialist aside from regular cleaning by the user.
- For specialist maintenance, contact the service shop where you bought the air conditioner.
- The maintenance cost must be in responsible of user.

Troubleshooting

■ These cases are not troubles.

- The following cases are not air conditioner troubles but have some reasons. You may just continue using it.

Indoor unit

The flaps do not start swing immediately.

- The air conditioner is adjusting the flap position. The flap will start moving soon.

The air conditioner stops generating airflow during HEAT operation.

- Once the set temperature is reached, the airflow rate is reduced and operation stopped in order to avoid generating a cool airflow. Operation will resume automatically when the indoor temperature falls.

The HEAT operation stops suddenly and a flowing sound is heard.

- The outdoor unit is taking away the frost. The HEAT operation starts after the frost on the outdoor unit is removed. You should wait for about 4 to 12 minutes.

Operation does not start soon.

- **When "ON/OFF" button was pressed soon after operation was stopped.**
- **When the mode was reselected.**
 - This is to protect the air conditioner. You should wait for about 3 minutes.

Outdoor unit

The outdoor unit emits water or steam.

- **In HEAT operation**
 - The frost on the outdoor unit melts into water or steam when the air conditioner is in defrost operation.
- **In COOL or DRY operation**
 - Moisture in the air condenses into water on the cool surface of outdoor unit piping and drips.



A sound is heard.

■ A sound like a flow of water

- This sound is generated because the refrigerant in the air conditioner is flowing.
- This is a pumping sound of the water in the air conditioner and heard when the water is pumped out from the air conditioner in cooling or drying operation.
- The refrigerant flows in the air conditioner even if the air conditioner is not working when the indoor units in other rooms are in operation.

■ Blowing sound

- This sound is generated when the flow of the refrigerant in the air conditioner is switching.

■ Ticking sound

- This sound is generated when the size of the air conditioner slightly expands or shrinks as a result of temperature changes.

■ Whistling sound

- This sound is generated when refrigerant flows during defrosting operation.

■ Clicking sound during operation or idle time

- This sound is generated when the refrigerant control valves or the electrical parts operate.

■ Clopping sound

- This sound is heard from the inside of the air conditioner when the exhaust fan is activated while the room doors are closed. Open the window or turn off the exhaust fan.

■ Rotating machinery causes sound

- Sound is heard when the vertical swing flaps and the horizontal swing flaps move.
- When the air conditioner is operating in a quiet environment and the airflow rate of the indoor unit is set to Quiet Mode or Low Mode, the motion of the swing flaps may cause sound.

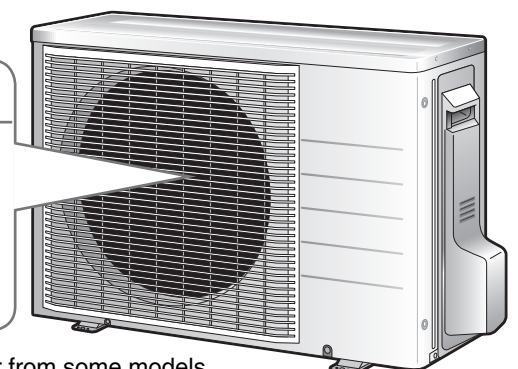

* The appearance of the outdoor unit may differ from some models.

- Troubleshooting measures are classified into the following two types on a remedial basis.
Take an appropriate measure according to the symptom.



Not trouble

- These cases are not troubles.



Check

- Please check again before calling service shop.

The air conditioner does not operate.

(OPERATION lamp is off.)

- Hasn't a breaker turned off or a fuse blown?
- Isn't it a power failure?
- Are batteries set in the remote controller?
- Is the timer setting correct?

(OPERATION lamp blinks)

- Turn off the power with the circuit breaker and restart operation with the remote controller.
If the OPERATION lamp is still blinking, check the error code and consult your dealer.



Cooling (Heating) effect is poor.

- Are the air filters clean?
- Is there anything to block the air inlet or the outlet of the indoor and the outdoor units?
- Is the temperature setting appropriate?
- Are the windows and doors closed?
- Are the airflow rate and the airflow direction set appropriately?
- Are outdoor ambient temperature not in operation range?
- Is the air conditioner in ECONO operation or OUTDOOR UNIT QUIET operation?



An abnormal functioning happens during operation.

- The air conditioner may malfunction with lightning or radio waves. Turn the breaker off, turn it on again and try operating the air conditioner with the remote controller.



Operation stopped suddenly. (OPERATION lamp blinks.)

- Are the air filters clean?
Clean the air filters.
- Is there anything to block the air inlet or the outlet of the indoor and the outdoor units?
- Turn the breaker off and take all obstacles away. Then turn it on again and try operating the air conditioner with the remote controller. If the lamp still flashes, call the service shop where you bought the air conditioner.



Operation stopped suddenly. (OPERATION lamp is on.)

- For system protection, the air conditioner may stop operating on a sudden large voltage fluctuation. It automatically resumes operation in about 3 minutes.



Mist comes out of the indoor unit.

- This happens when the air in the room is cooled into mist by the cold airflow during COOL operation.



Troubleshooting

Hot air does not flow out soon after the start of HEAT operation.

- The air conditioner is warming up. You should wait for 1 to 4 minutes. (The system is designed to start discharging air only after it has reached a certain temperature.)



The ON/OFF TIMER does not operate according to the settings.

- Check if the ON/OFF TIMER correct the actual length of timer can be differ from user setted time for approx. 10 minutes.



Remote controller does not work properly.

- **No remote controller signals are displayed.**
- **The remote controller sensitivity is low.**
- **The LCD blinks and the remote controller stop operate.**
 - The batteries are drying and the remote controller is malfunctioning. Replace all the batteries with new, size AAA.LR03 (alkaline). For details, refer to set the batteries of this manual. [▶Page 8](#)
- **The unit does not receive signals from remote controller or has a limited operating range.**
 - Signal communication may be disabled if an electronic-starter-type fluorescent lamp (such as inverter-type lamps) is in the room. Consult your dealer if that is in this case.
 - The remote controller may not function correctly if the transmitter is exposed to direct sunlight.
- **Other electronic devices start operating.**
 - If the remote controller activates other electronic devices, move them away or consult your dealer.



The outdoor fan rotates while the air conditioner is not in operation.

- **After operation is stopped**
 - The outdoor fan continues rotating for another 60 seconds for system protection.
- **While the air conditioner is not in operation**
 - When the outdoor temperature is very high, the outdoor fan starts rotating for system protection.



The indoor unit gives out odour.

- This happens when smells of the room, furniture, or cigarettes are absorbed into the unit and discharged with the airflow.
(If this happens, we recommend you to have the indoor unit washed by a technician. Consult the service shop where you bought the air conditioner.)



■ Call the service shop immediately

WARNING

- **When an abnormality (such as a burning smell) occurs, stop operation and turn the breaker off.**
 - Continued operation in an abnormal condition may result in troubles, electric shocks or fire.
 - Consult the service shop where you bought the air conditioner.
- **Do not attempt to repair or modify the air conditioner by yourself.**
 - Incorrect work may result in electric shocks or fire.
 - Consult the service shop where you bought the air conditioner.

If one of the following symptoms takes place, call the service shop immediately.

- The power cord is abnormally hot or damaged.
- An abnormal sound is heard during operation.
- The safety breaker, a fuse, or the earth leakage breaker cuts off the operation frequently.
- A switch or a button often fails to work properly.
- There is a burning smell.
- Water leaks from the indoor unit.

Turn the breaker off and call the service shop.



■ After a power failure

- The air conditioner automatically resumes operation in about 3 minutes. You should just wait for a while.

■ Lightning

- If lightning may strike the neighbouring area, stop operation and turn the breaker off for system protection.

■ Disposal requirements

- Dismantling of the unit, treatment of the refrigerant, oil and eventual other parts, should be done in accordance with the relevant local and national regulations.

Troubleshooting

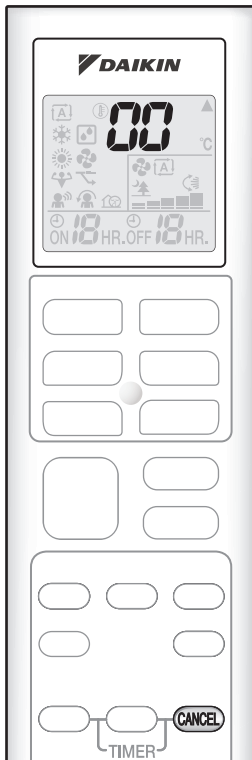

■ Fault diagnosis by remote controller

- In case the air conditioner is malfunctioning, you can check the error code via the remote controller before consulting with service personnel and informing them of the malfunction code.

1. When **CANCEL is held down for 5 seconds, a “00” indication blinks on the temperature display section.**

2. Press **CANCEL repeatedly until a continuous beep is produced.**

- The code indication changes as shown below, and notifies with a long beep.

| | CODE | MEANING |
|--------------|---|--|
| SYSTEM | 00 | NORMAL |
| | UA | INDOOR-OUTDOOR UNIT COMBINATION FAULT |
| | U0 | REFRIGERANT SHORTAGE |
| | U2 | DROP VOLTAGE OR MAIN CIRCUIT OVERVOLTAGE |
| | U4 | FAILURE OF TRANSMISSION (BETWEEN INDOOR UNIT AND OUTDOOR UNIT) |
| INDOOR UNIT | A1 | INDOOR PCB DEFECTIVENESS |
| | A5 | HIGH PRESSURE CONTROL OR FREEZE-UP PROTECTOR |
| | A6 | FAN MOTOR FAULT |
| | C4 | FAULTY HEAT EXCHANGER TEMPERATURE SENSOR |
| | C9 | FAULTY SUCTION AIR TEMPERATURE SENSOR |
| OUTDOOR UNIT | EA | COOLING-HEATING SWITCHING ERROR |
| | E1 | CIRCUIT BOARD FAULT |
| | E5 | OL STARTED |
| | E6 | FAULTY COMPRESSOR START UP |
| | E7 | DC FAN MOTOR FAULT |
| | E8 | OVERCURRENT INPUT |
| | F3 | HIGH TEMPERATURE DISCHARGE PIPE CONTROL |
| | F6 | HIGH PRESSURE CONTROL (IN COOLING) |
| | H0 | SENSOR FAULT |
| | H6 | OPERATION HALT DUE TO FAULTY POSITION DETECTION SENSOR |
| | H8 | DC CURRENT SENSOR FAULT |
| | H9 | FAULTY SUCTION AIR TEMPERATURE SENSOR |
| | J3 | FAULTY DISCHARGE PIPE TEMPERATURE SENSOR |
| | J6 | FAULTY HEAT EXCHANGER TEMPERATURE SENSOR |
| | L3 | ELECTRICAL PARTS HEAT FAULT |
| L4 | HIGH TEMPERATURE AT INVERTER CIRCUIT HEATSINK | |
| L5 | OUTPUT OVERCURRENT | |
| P4 | FAULTY INVERTER CIRCUIT HEATSINK TEMPERATURE SENSOR | |

NOTE

- A short beep and two consecutive beeps indicate non-corresponding codes.
- To cancel the code display, hold **CANCEL** for 5 seconds. The code display also cancel itself if the button is not pressed for 1 minute.

MEMO

A large, empty white rectangular area with rounded corners, intended for writing a memo. It occupies the majority of the page below the 'MEMO' header.

MEMO



MEMO

A large, empty white rectangular area with rounded corners, intended for writing a memo. It occupies the majority of the page below the 'MEMO' header.

Quick Reference

MODES:

- AUTO:** Automatically selects the most appropriate mode based on the current room temperature.
- COOL:** Cools the room.
- DRY:** Removes excess moisture from the air.
- HEAT:** Heats the room.
- FAN ONLY:** Operates the fan without heating or cooling.

TEMP: Temperature control. Press the up/down arrows to adjust the set temperature.

FAN: Fan speed control. Press the FAN button to cycle through fan speeds.

SWING: Swing function. Press the SWING button to oscillate the fan blades.

OFF: Turns the air conditioner off.

DISPLAY: The LCD display shows the current mode, set temperature (88.8°C), and a timer (ON 18 HR. OFF 18 HR.).

DAIKIN INDUSTRIES, LTD.

Head office:
 Umeda Center Bldg., 2-4-12, Nakazaki-Nishi,
 Kita-ku, Osaka, 530-8323 Japan

Tokyo office:
 JR Shinagawa East Bldg., 2-18-1, Konan,
 Minato-ku, Tokyo, 108-0075 Japan
<https://www.daikin.com>



The two-dimensional bar code is a manufacturing code.